

TM2001

3/4" X 6" +-

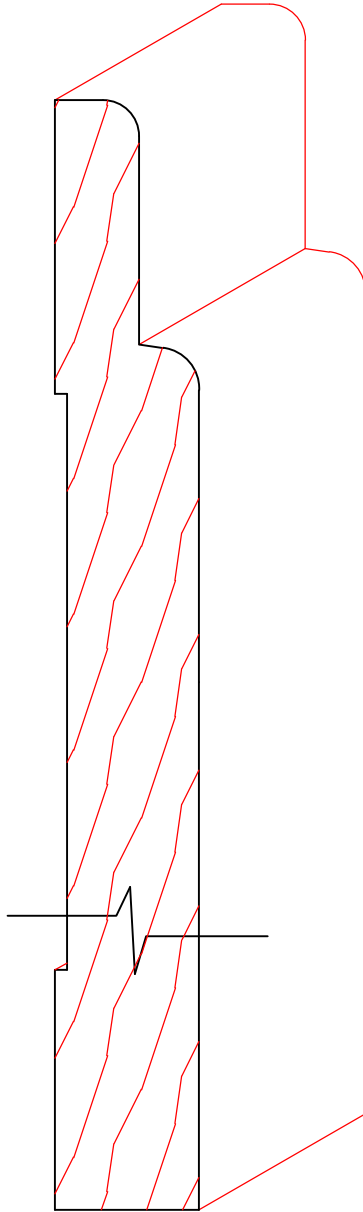

TM2002

3/4" X 5-1/4" +-

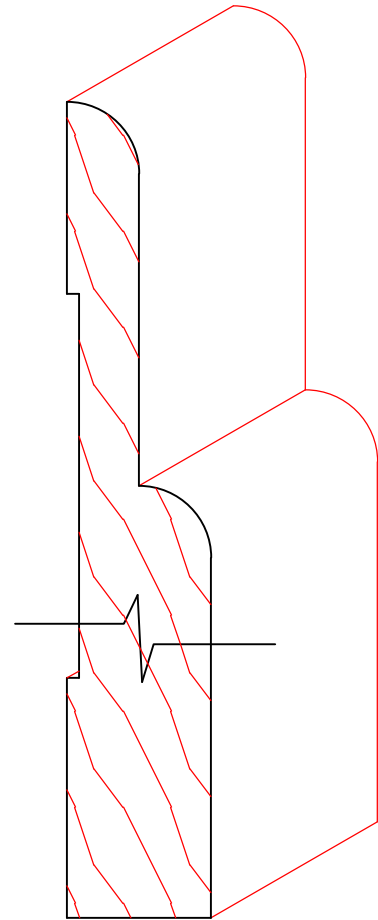

TM2003

3/4" X 4-1/4" +-

THOMAS AND MILLIKEN MILLWORK, INC.

FULL
SCALE

1

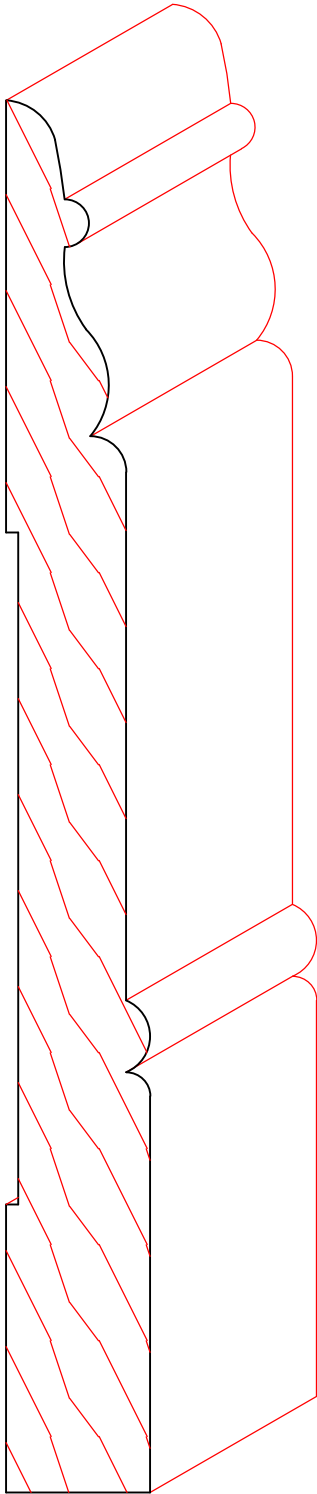

TM2004
3/4" X 7-1/4"

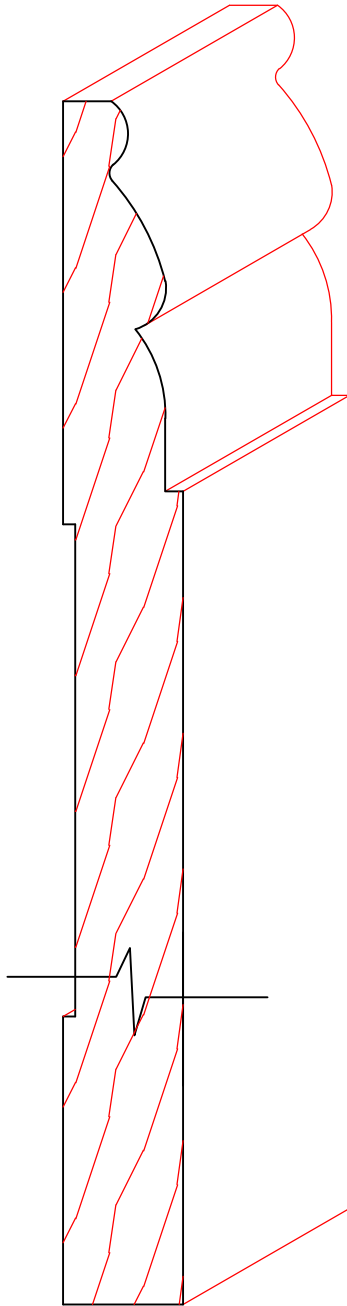

TM2005
5/8" X 6-1/4"±

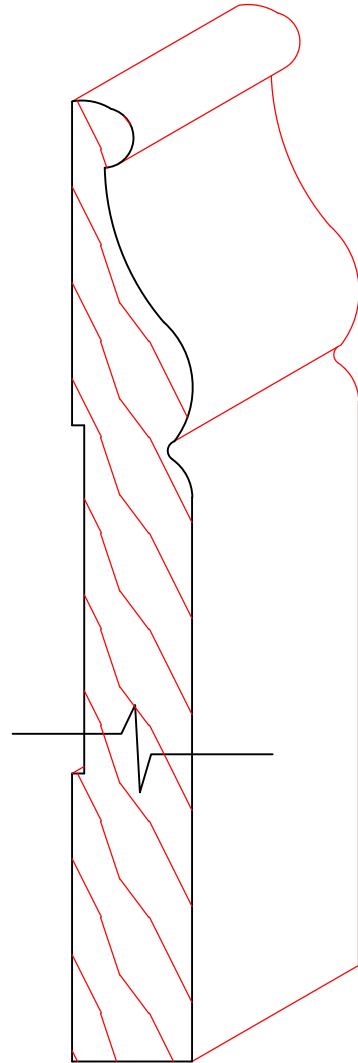

TM2006
5/8" X 5-1/4"±

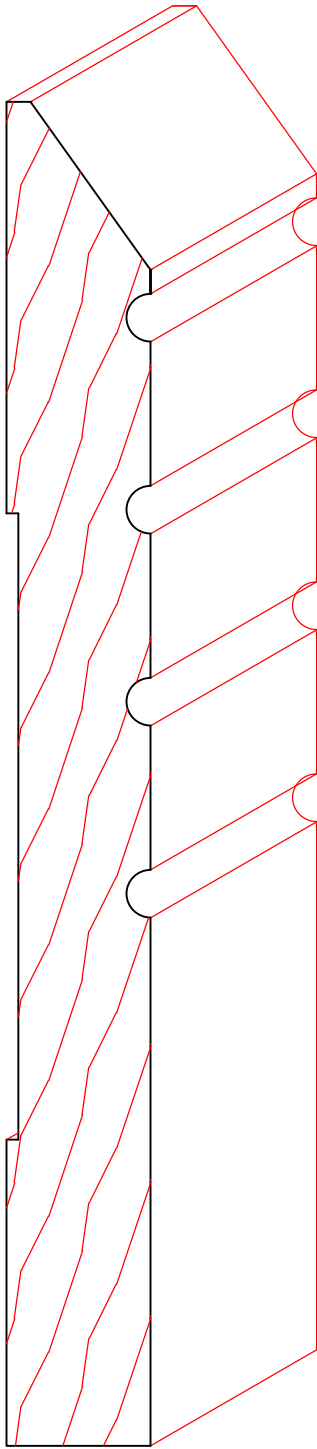

TM2007
3/4" X 7"

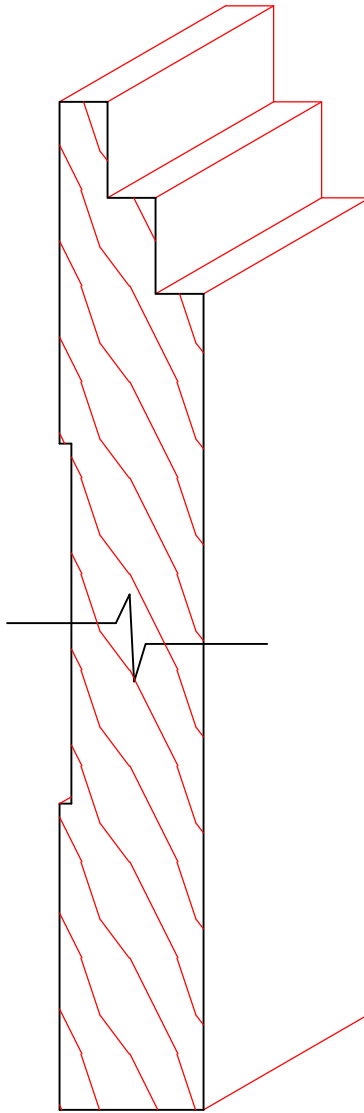

TM2008
3/4" X 5-1/4"±

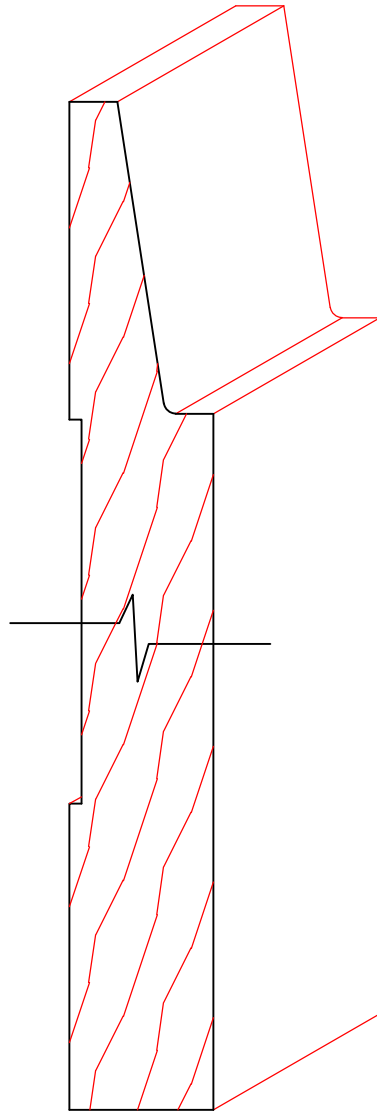

TM2009
3/4" X 5-1/4"±

THOMAS AND MILLIKEN MILLWORK, INC.

FULL
SCALE

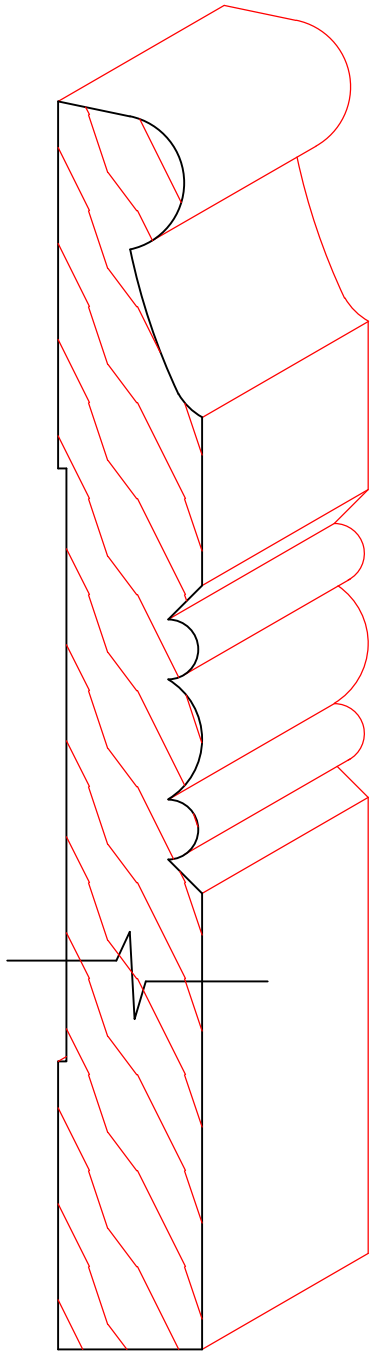

TM2010

3/4" X 6-1/2" +-



TM2011

3/4" X 6-1/2" +-

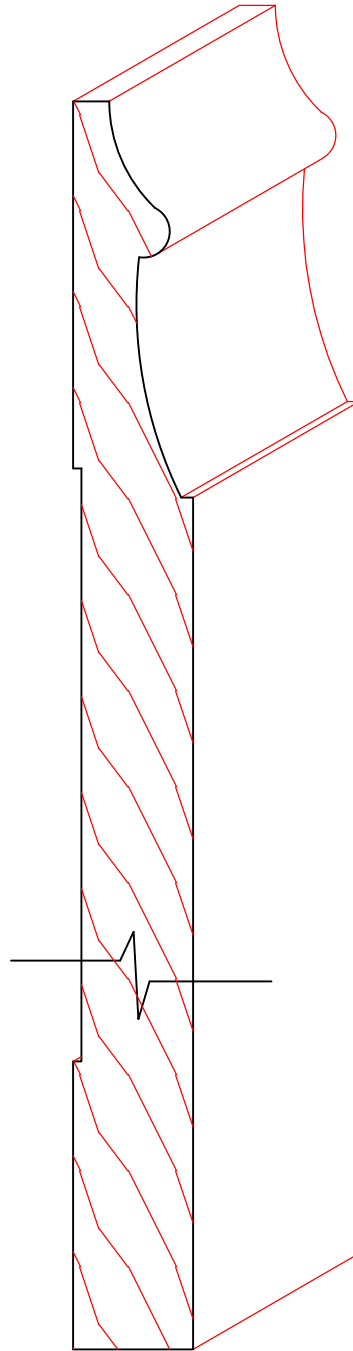

TM2012

5/8" X 6-1/2" +-

THOMAS AND MILLIKEN MILLWORK, INC.

FULL
SCALE

4

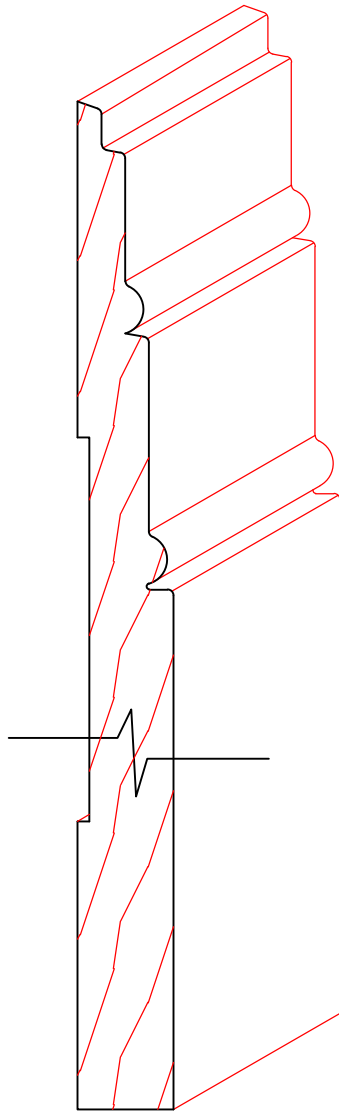

TM2013
1/2" X 5-1/4" +-

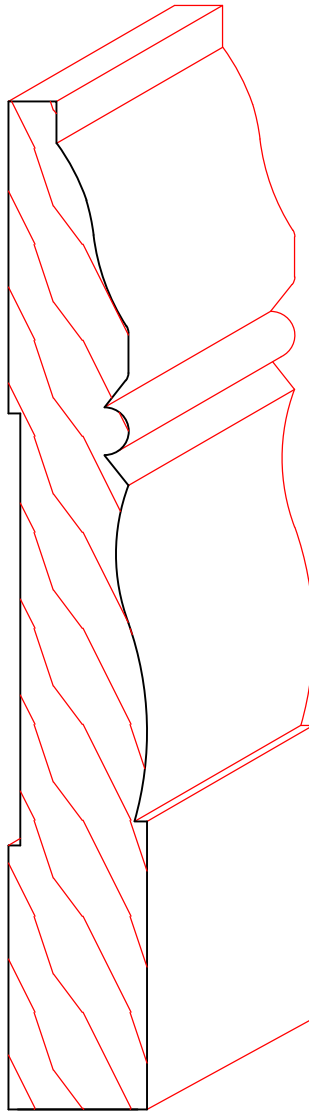

TM2014
3/4" X 5-1/4"

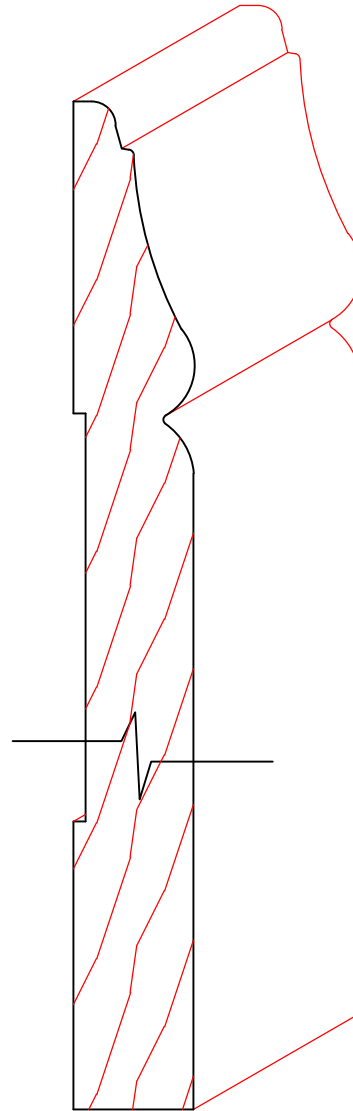

TM2015
5/8" X 5-1/4" +-

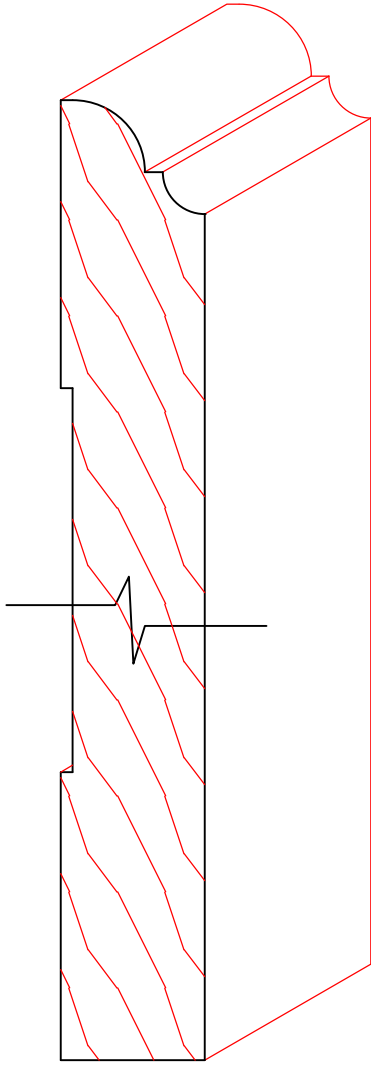

TM2016
3/4" X 5" +-

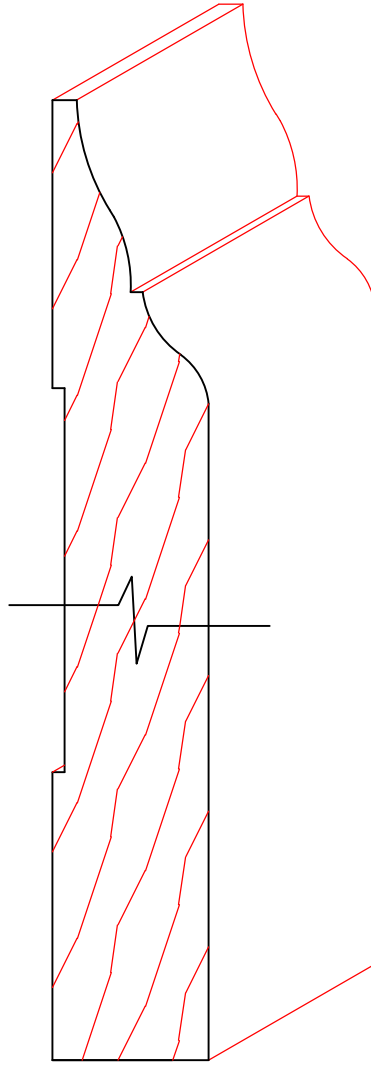

TM2017
13/16" X 5" +-

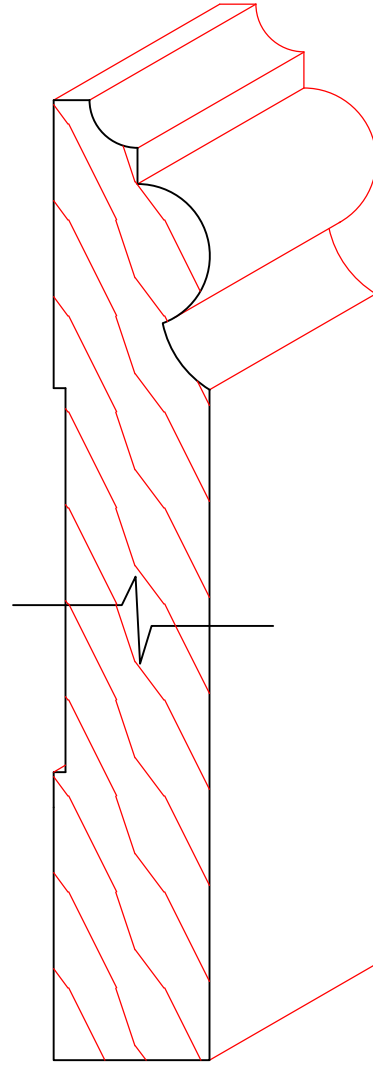

TM2018
13/16" X 5" +-

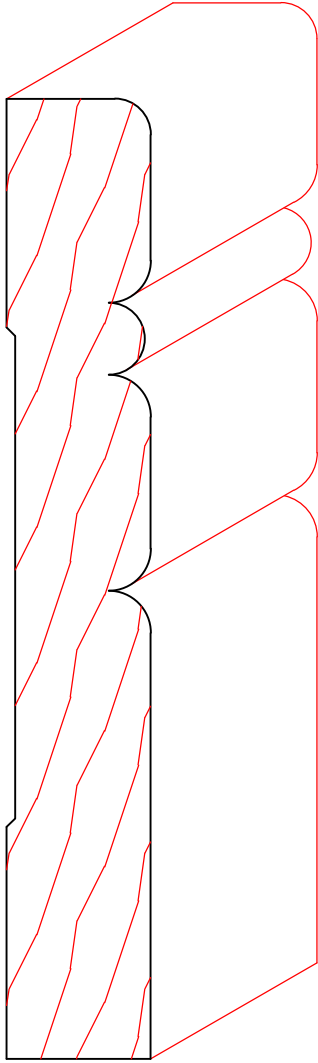

TM2019
3/4" X 5"

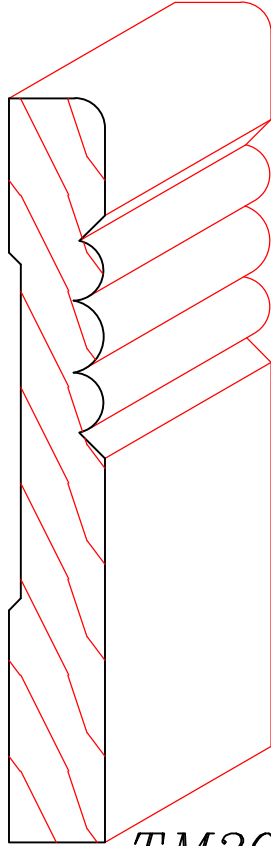

TM2020
1/2" X 3-7/8"

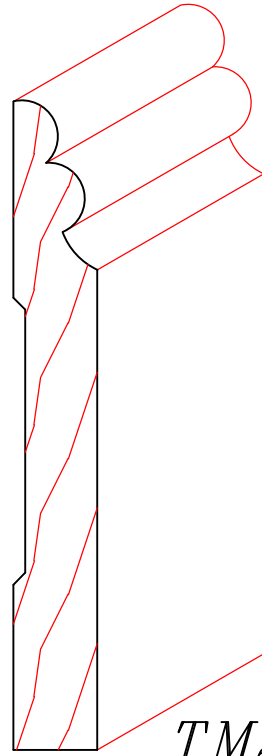

TM2021
7/16" X 3-3/8"

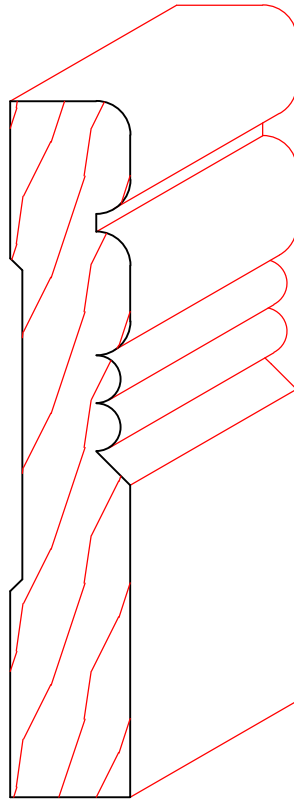

TM2022
5/8" X 3-5/8"

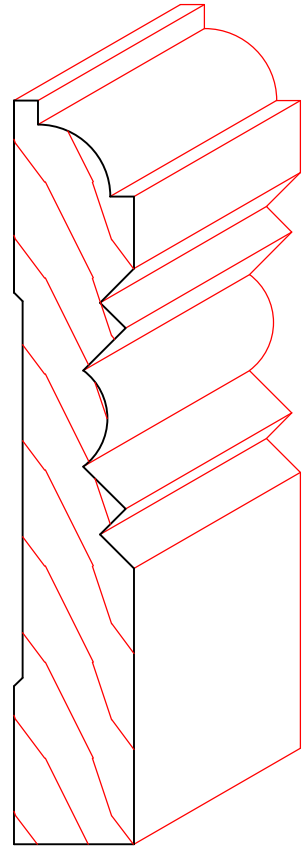

TM2023
5/8" X 3-7/8"

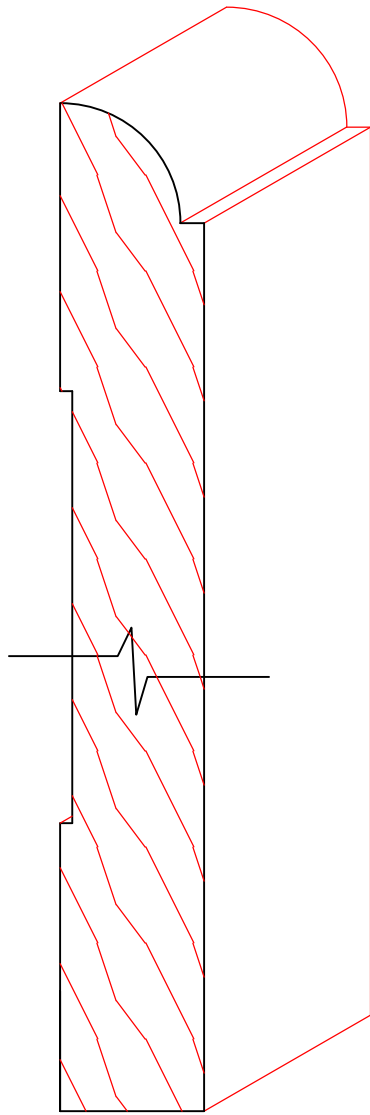

TM2024

3/4" X 5-1/4" +-

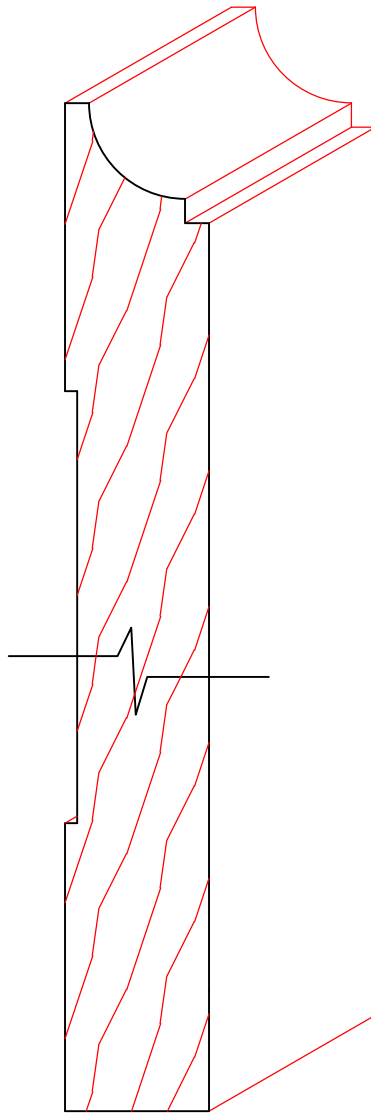

TM2025

3/4" X 5-1/4" +-

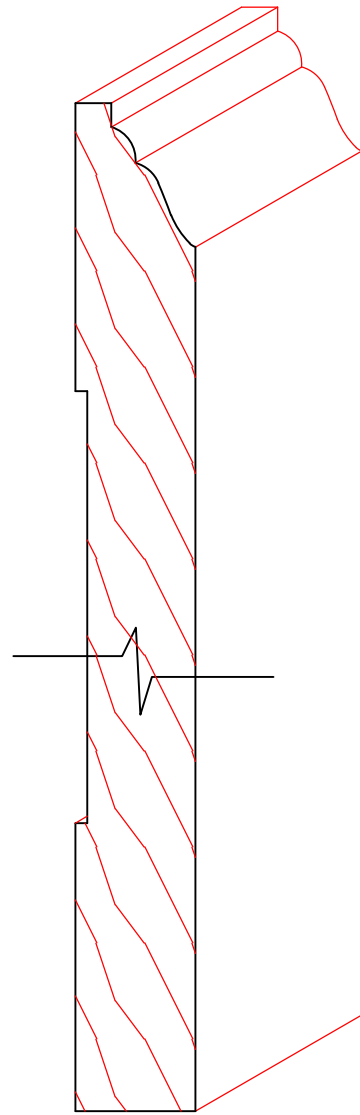

TM2026

5/8" X 5-1/4" +-

THOMAS AND MILLIKEN MILLWORK, INC.

FULL
SCALE

∞

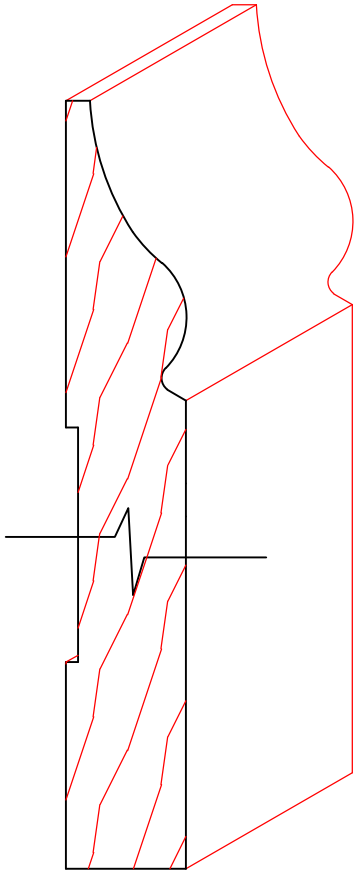

TM2027
5/8" X 4" +-

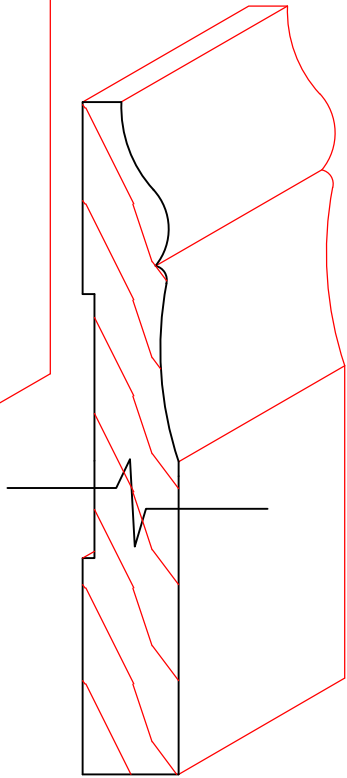

TM2028
1/2" X 3-1/2" +-

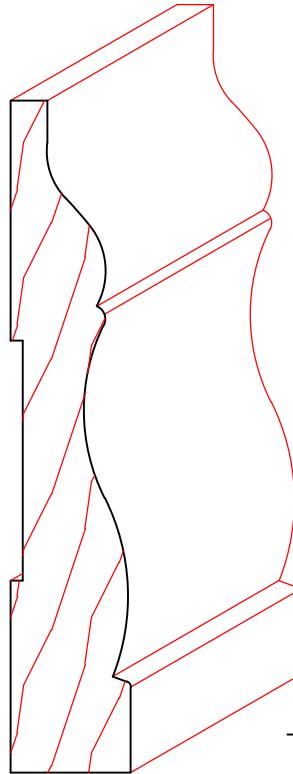

TM2029
5/8" X 3-1/2" +-

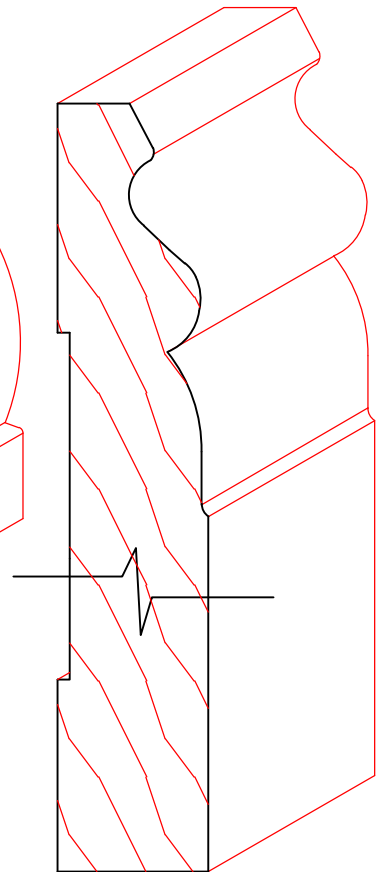

TM2030
3/4" X 4" +-

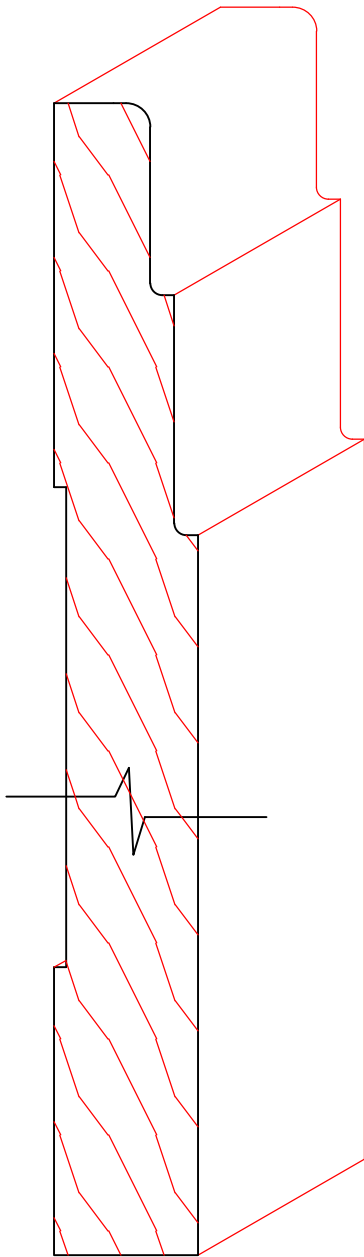

TM2031
3/4" X 6"±

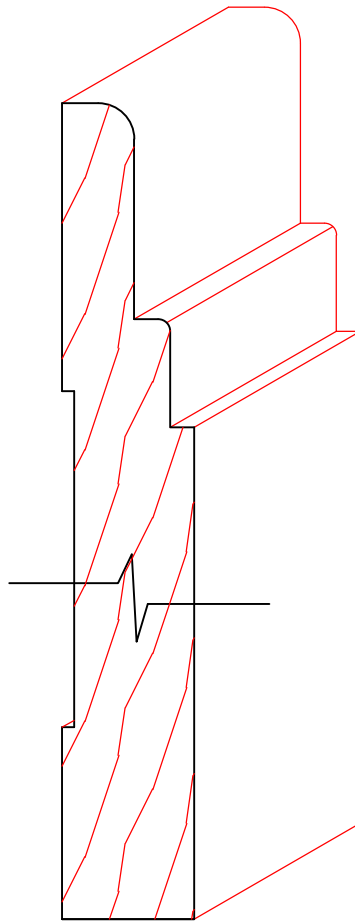

TM2032
3/4" X 4-1/4"±

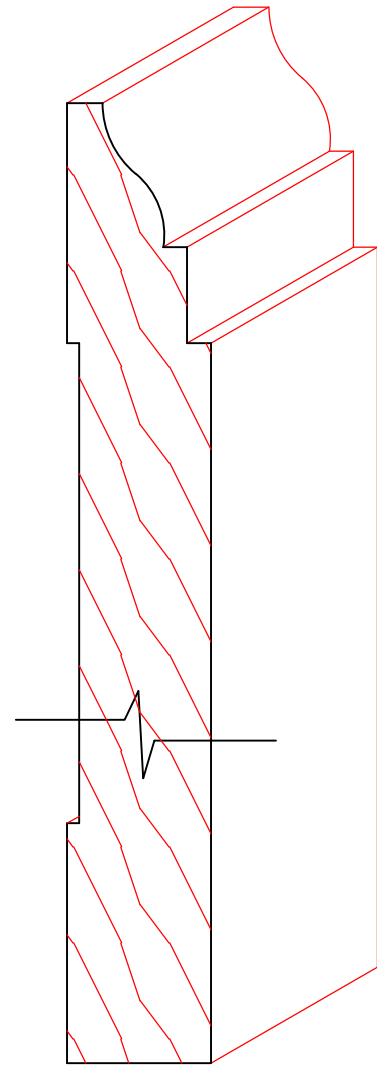

TM2033
5/8" X 5"±



TM2034
3/4" X 6-5/16"

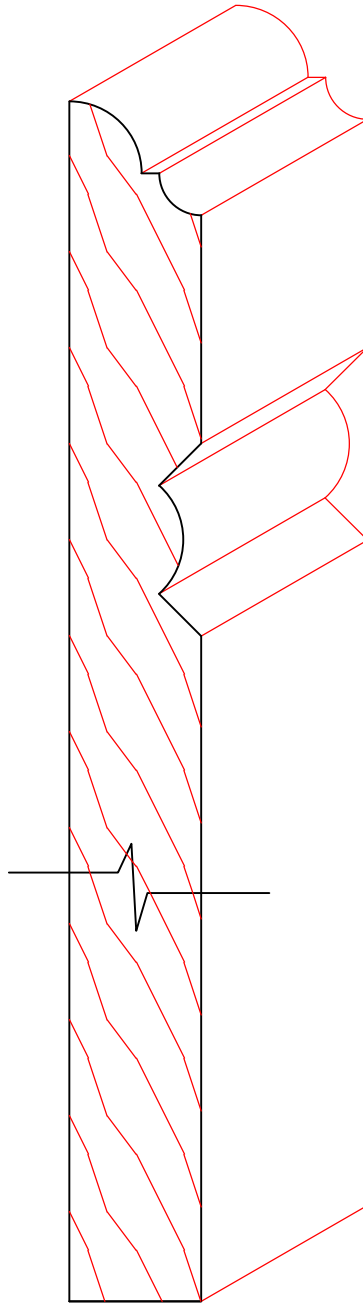

TM2035
3/4" X 6-1/4" +-

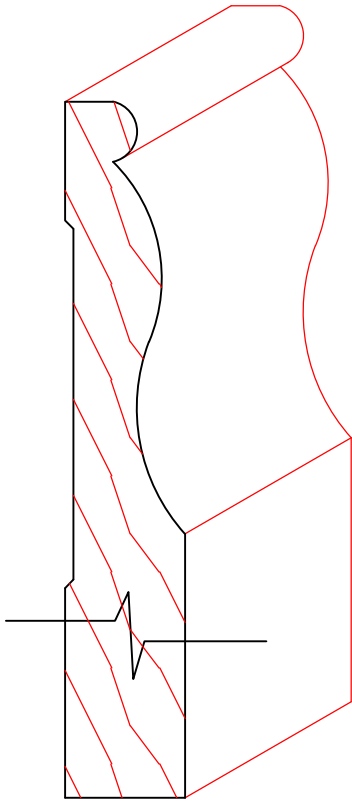

TM2037
5/8" X 3-5/8" +-

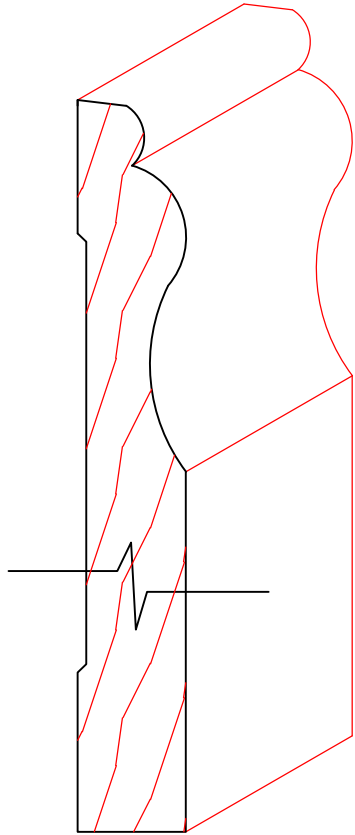

TM2038
9/16" X 3-13/16" +-

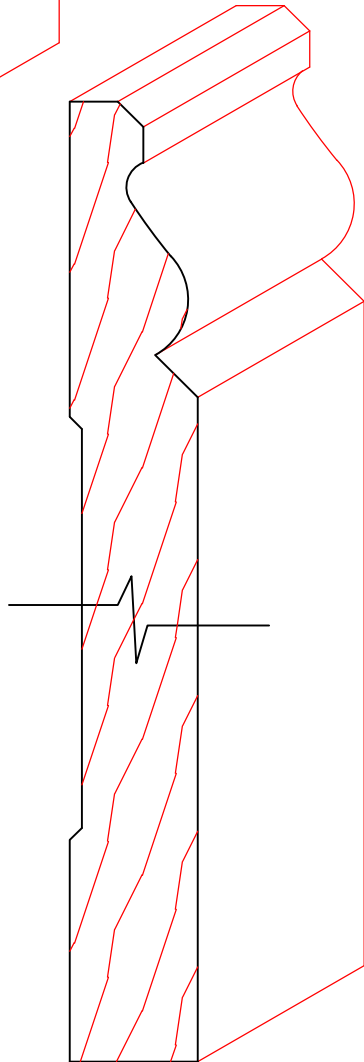

TM2039
11/16" X 5" +-

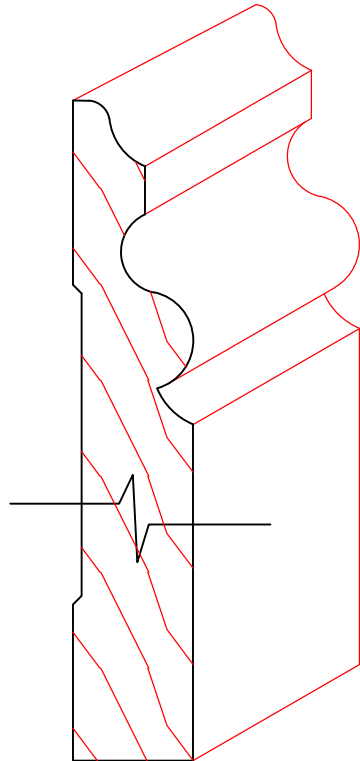

TM2040
5/8" X 3-3/4" +-

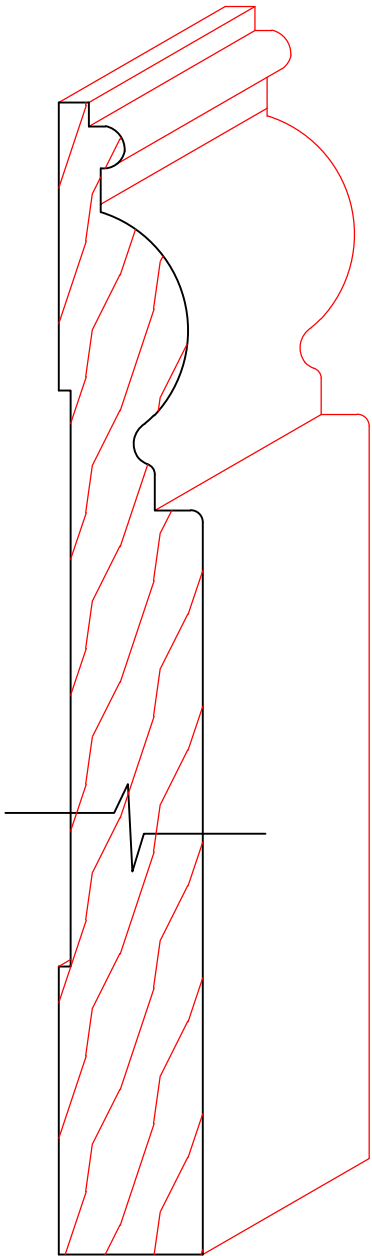

TM2041
3/4" X 6" +-

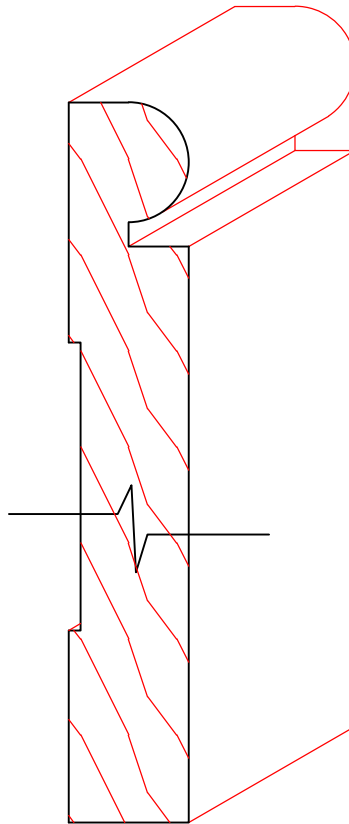

TM2042
5/8" X 3-3/4" +-

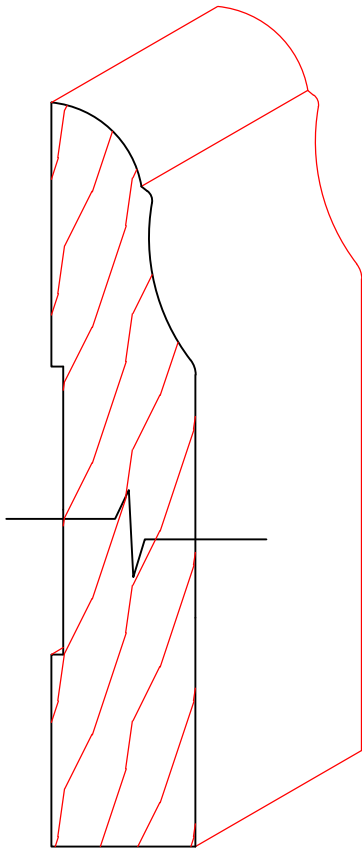

TM2043

13/16" X 3-3/4" +-

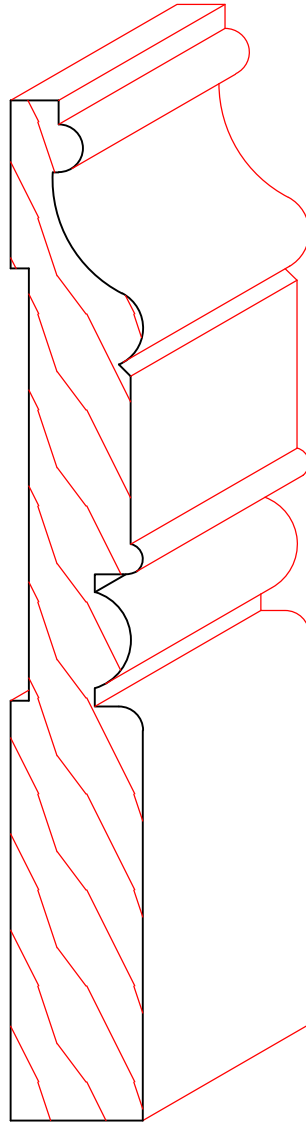

TM2044

11/16" X 5-1/4"

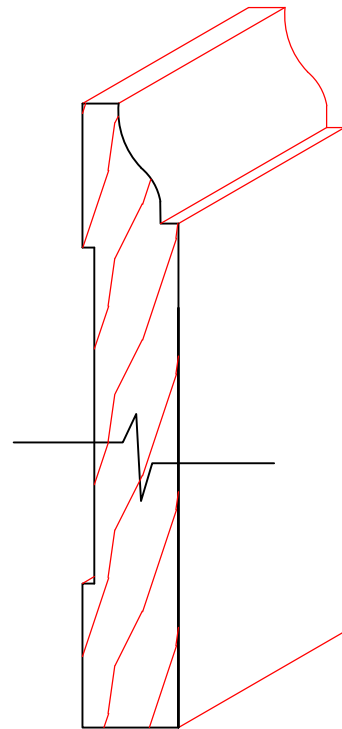

TM2045

1/2" X 3-1/4" +-

THOMAS AND MILLIKEN MILLWORK, INC.

FULL
SCALE

14



TM2046
3/4" X 8"

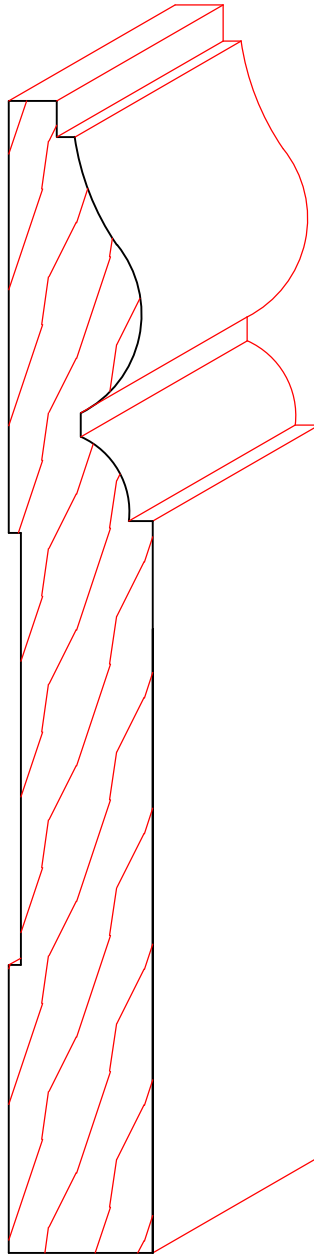

TM2047
3/4" X 6"

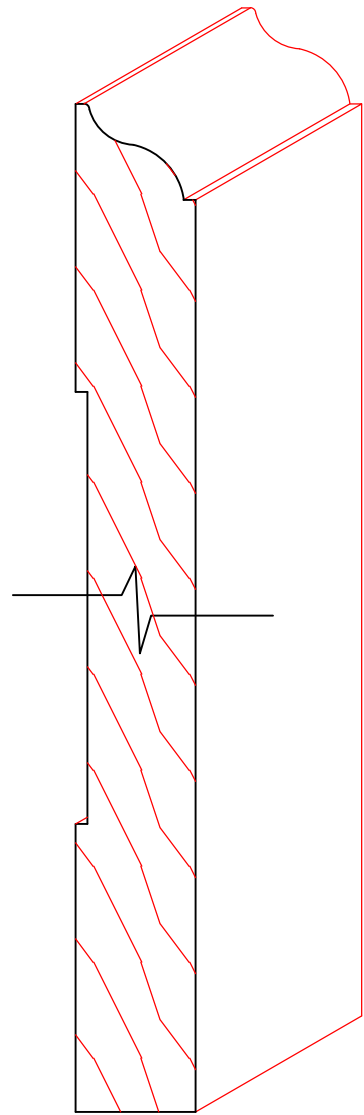

TM2048
5/8" X 5-1/4" +-

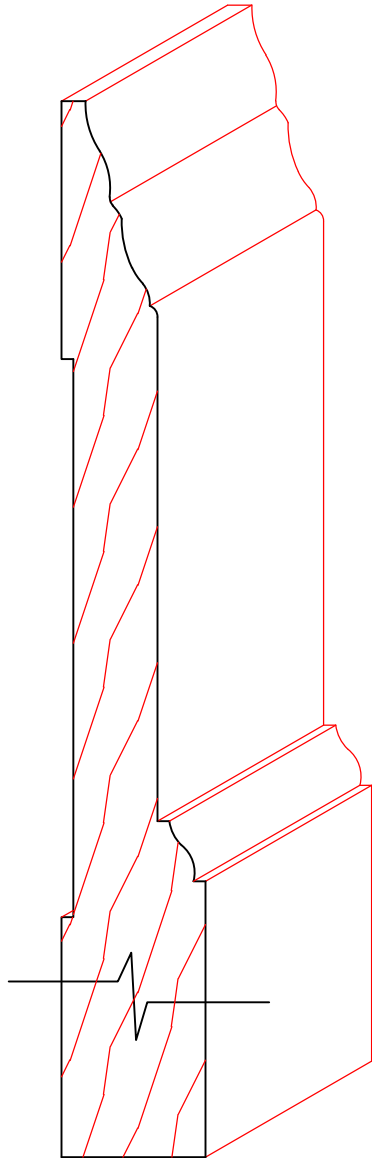

TM2049
3/4" X 5-1/2" +-

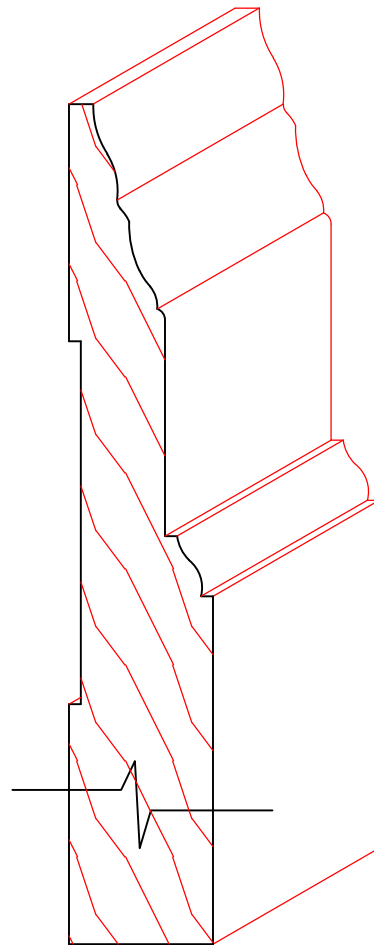

TM2050
3/4" X 4-3/8" +-

TM2054
3/8" X 3-1/2" +-

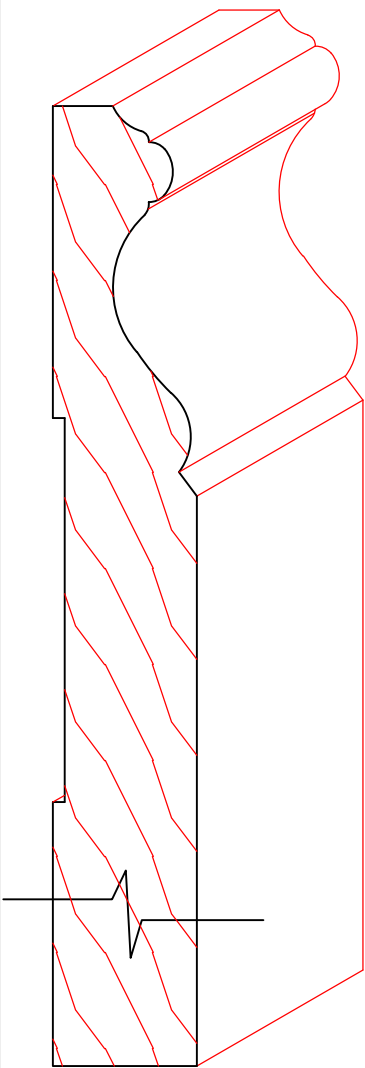
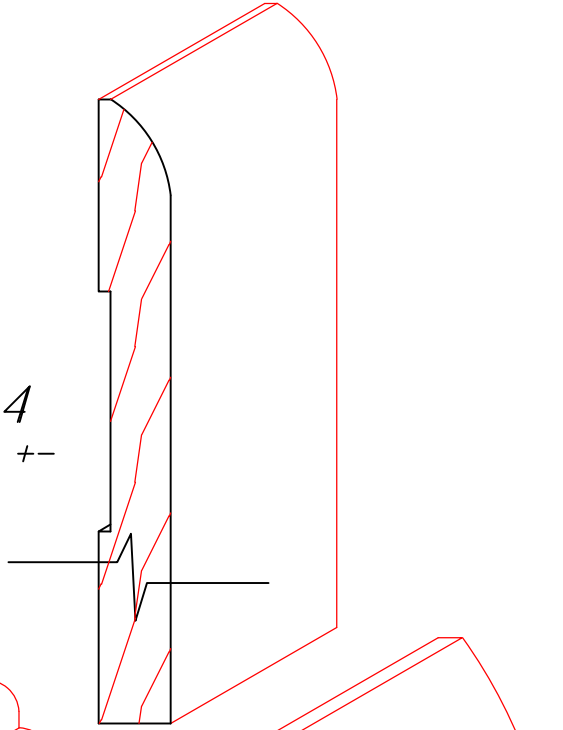

TM2051
3/4" X 5" +-

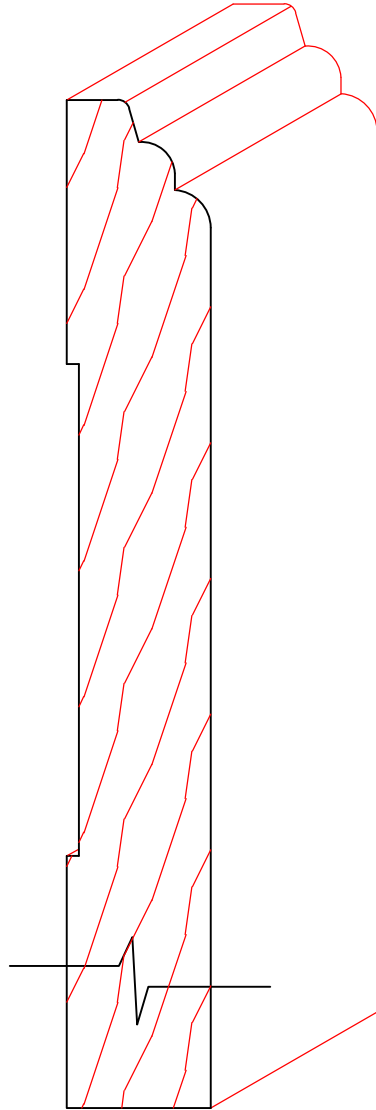

TM2052
3/4" X 5-1/4" +-

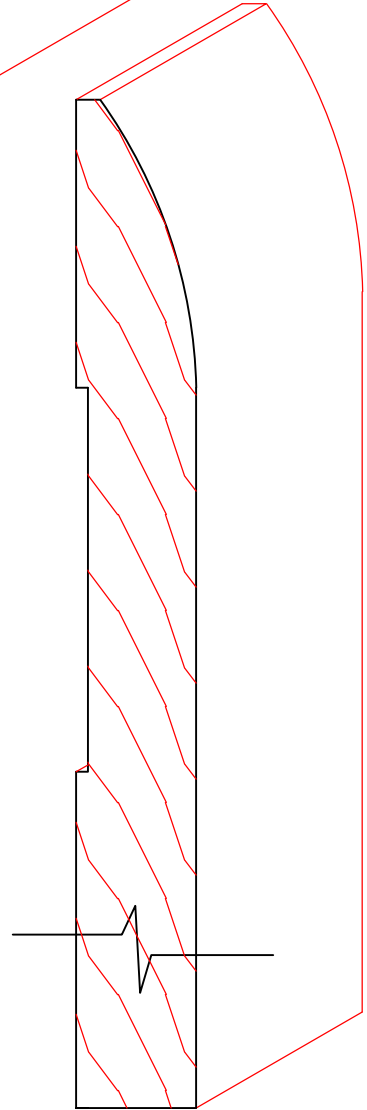

TM2053
5/8" X 5-1/4" +-

THOMAS AND MILLIKEN MILLWORK, INC.

FULL
SCALE

17

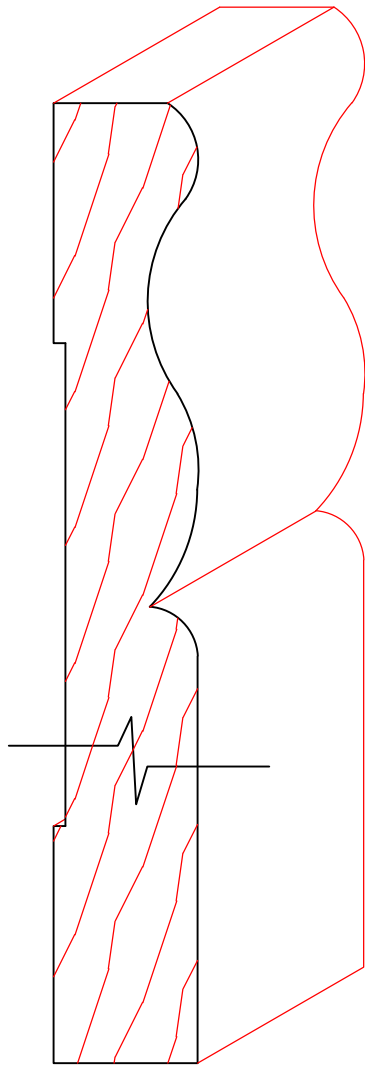

TM2055
3/4" X 5" +-

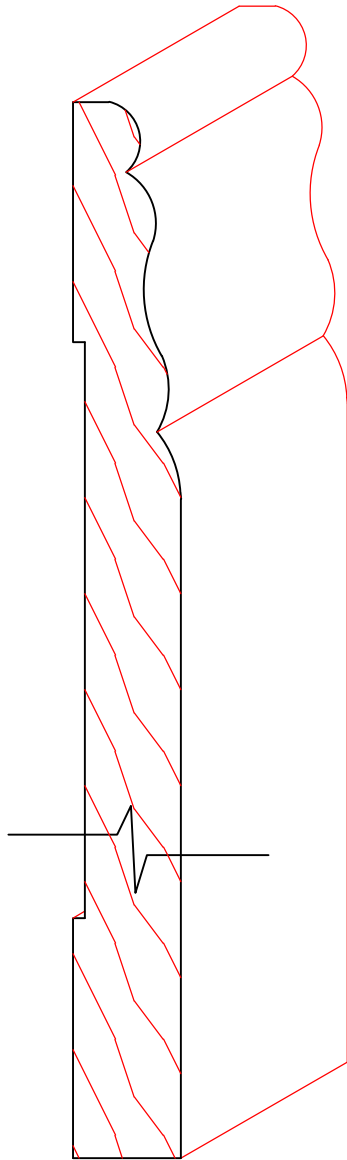

TM2056
9/16" X 5-1/2" +-

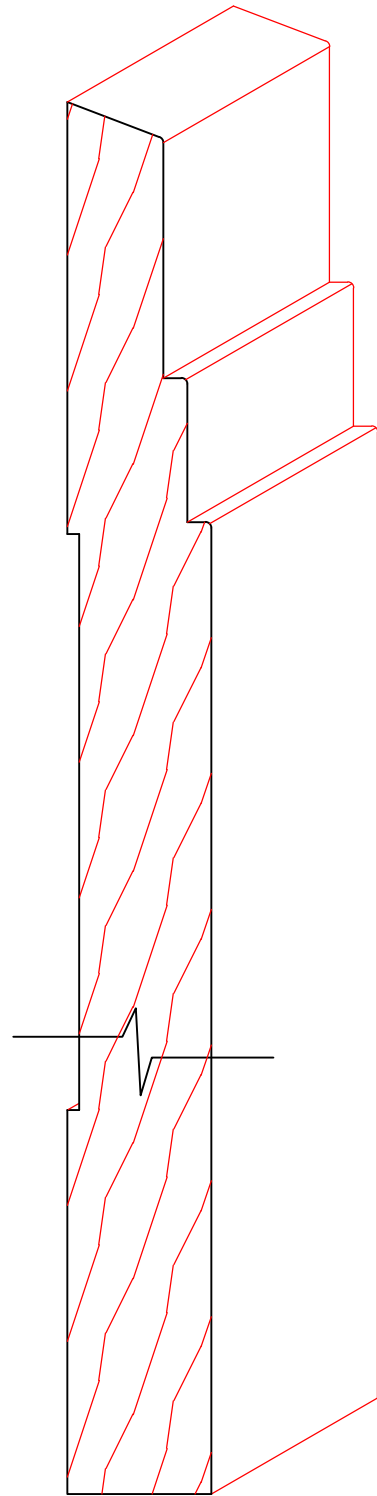

TM2057
3/4" X 7-1/4" +-

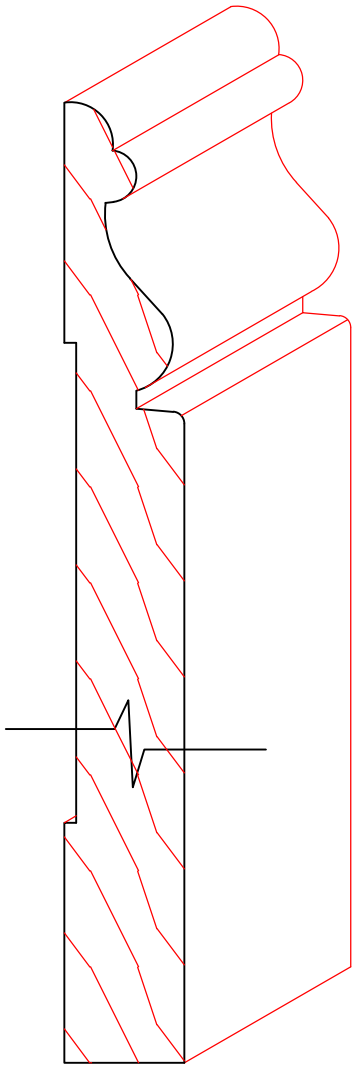

TM2058
5/8" X 5" +-

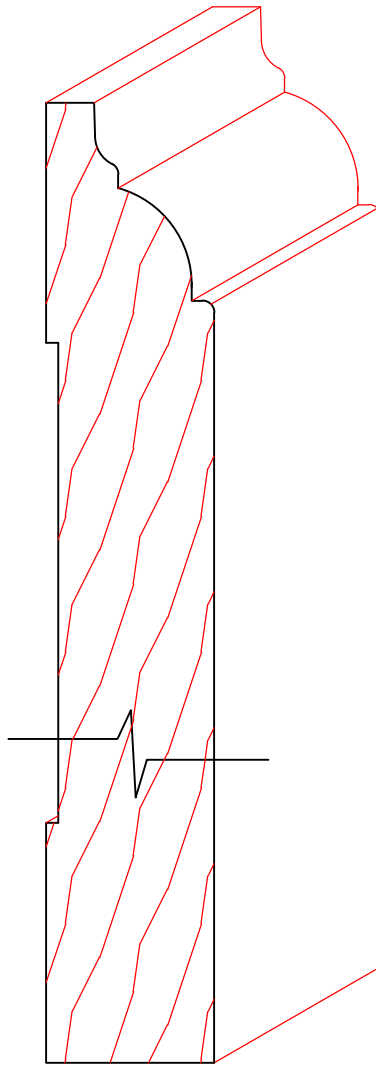

TM2059
13/16" X 5" +-

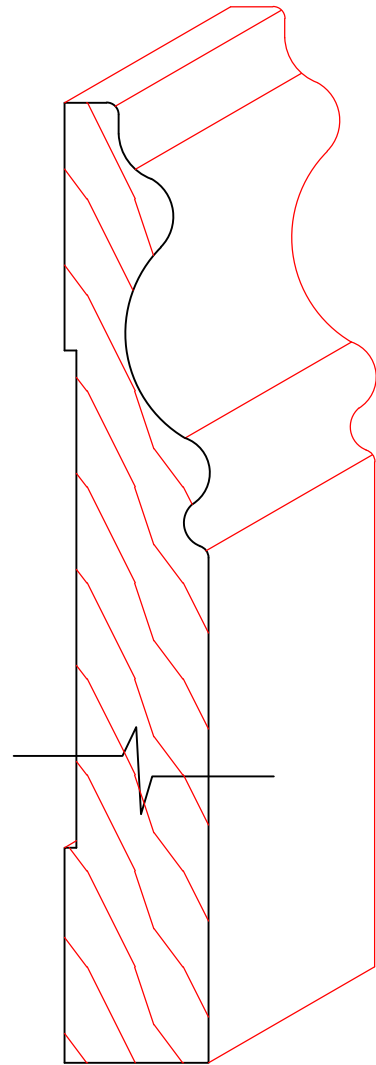

TM2060
3/4" X 5" +-

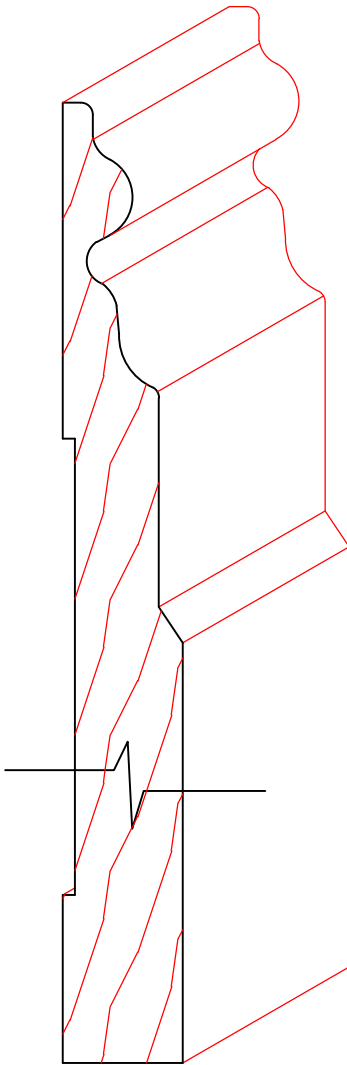

TM2061
5/8" X 5" +-

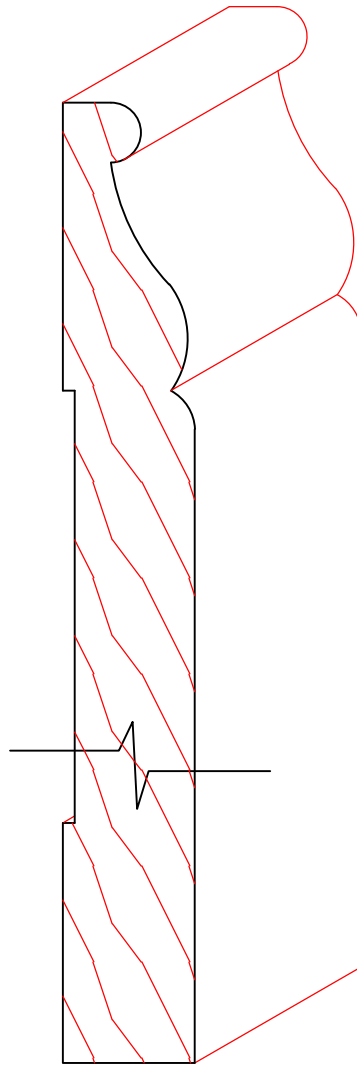

TM2062
11/16" X 5" +-

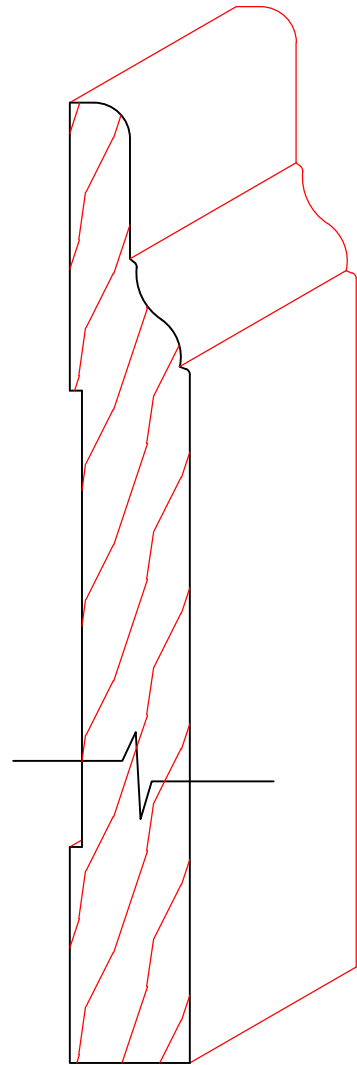

TM2063
5/8" X 5" +-

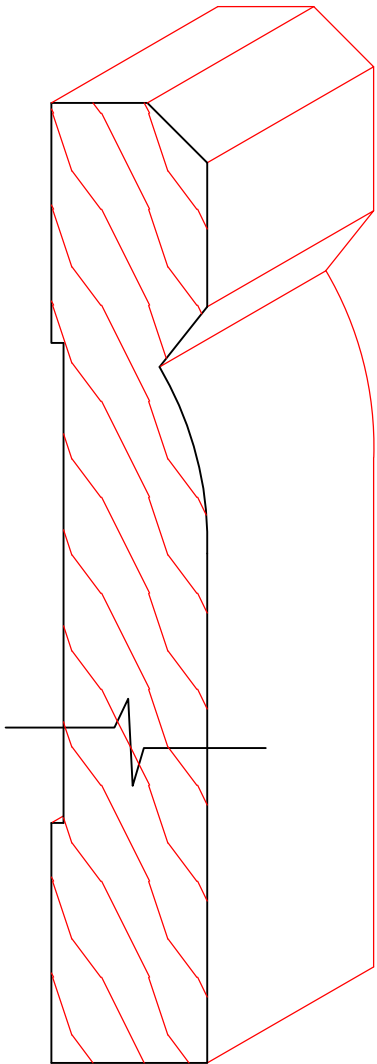

TM2064
13/16" X 5" +-

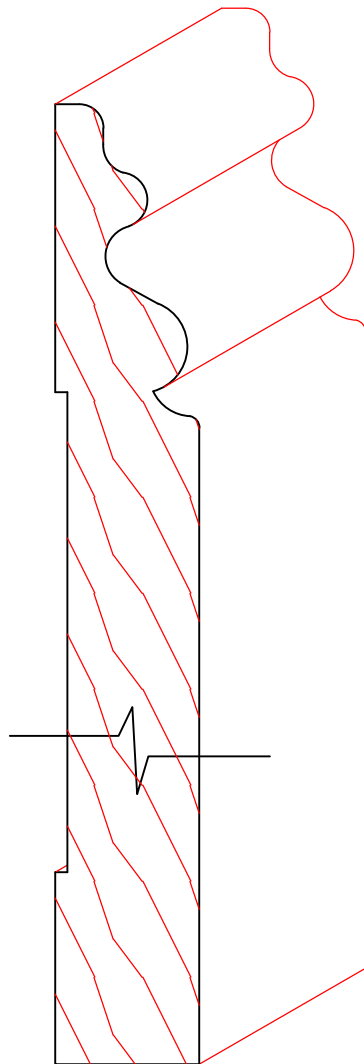

TM2065
3/4" X 5" +-

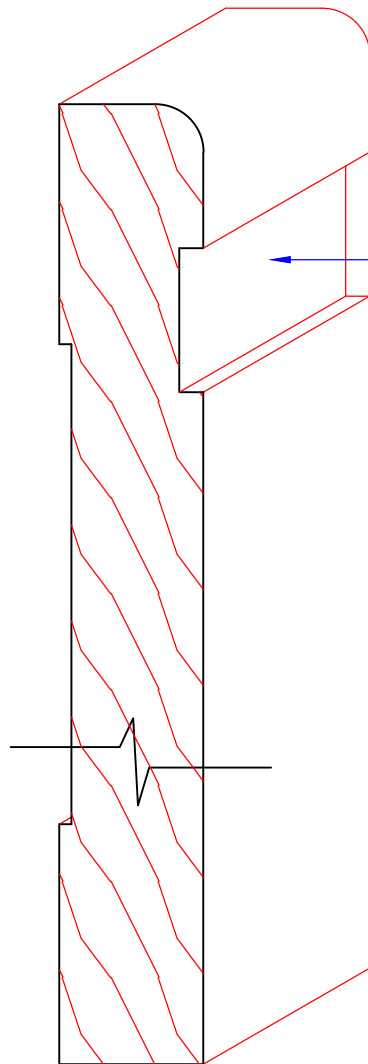

PLACE
INLAY
HERE

TM2066
3/4" X 5" +-

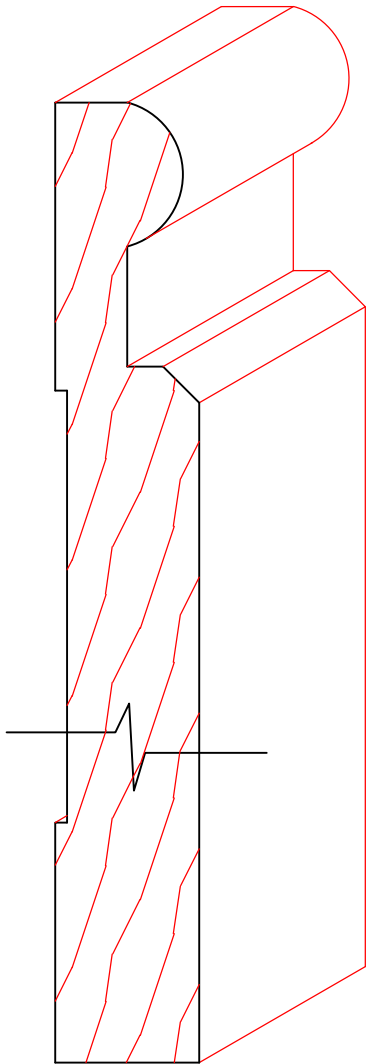

TM2067
3/4" X 5" +-

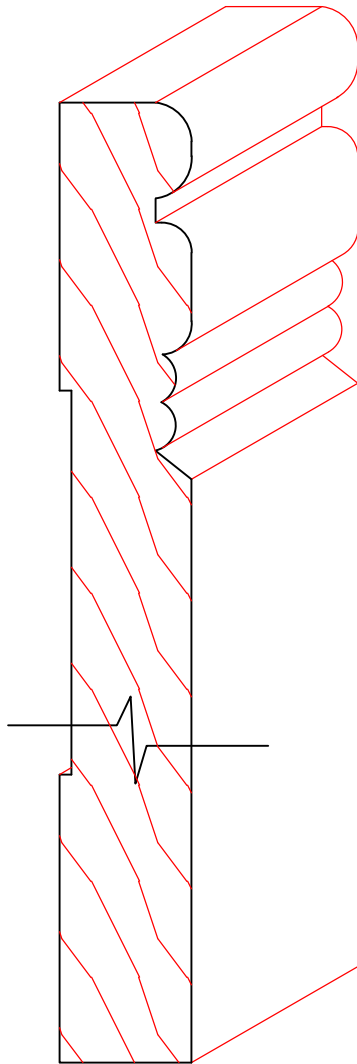

TM2068
11/16" X 5" +-

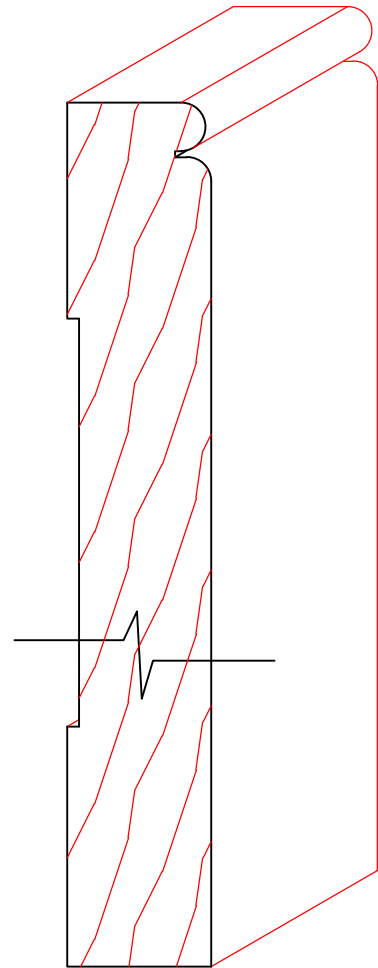

TM2069
3/4" X 4-1/2"

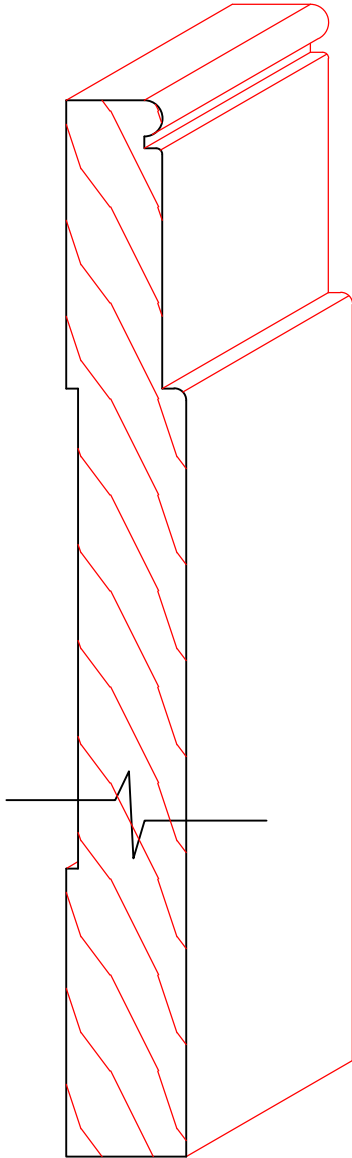

TM2070
5/8" X 5-1/2" +-

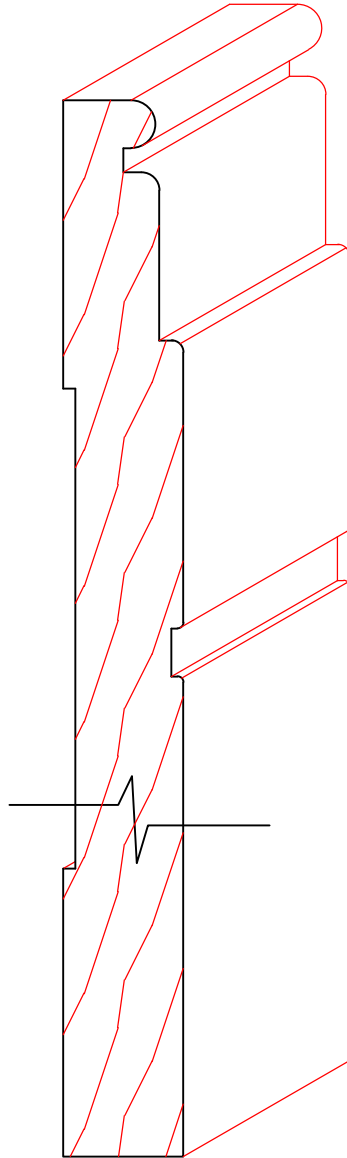

TM2071
5/8" X 5-1/2" +-

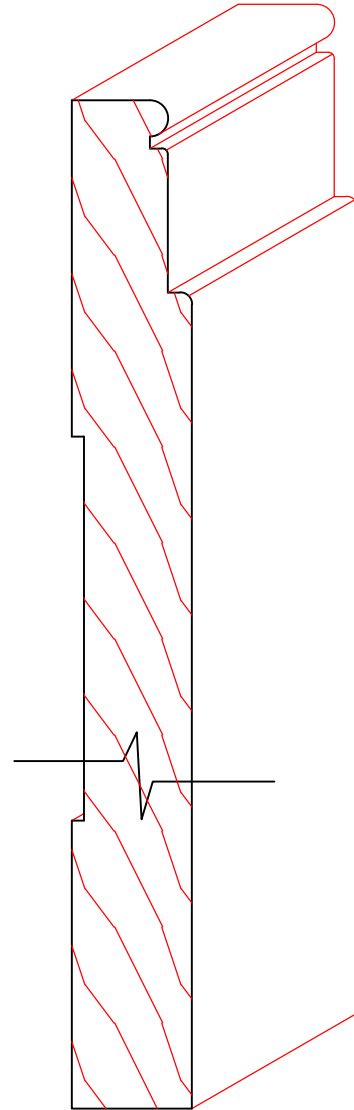

TM2072
5/8" X 5-1/4" +-

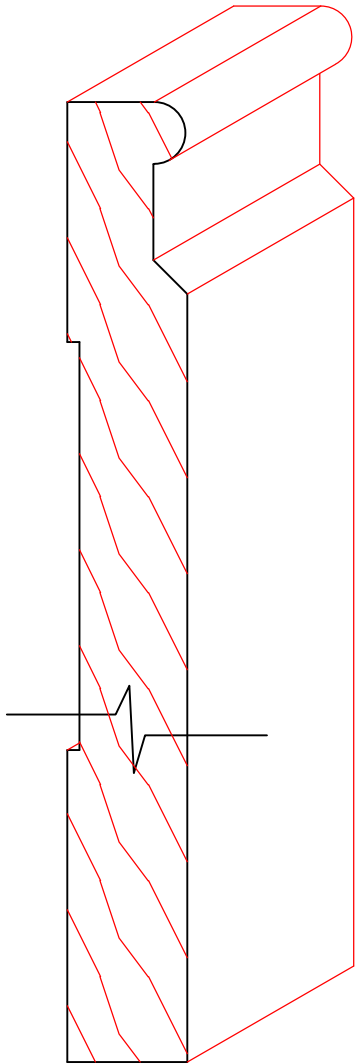

TM2073
5/8" X 5" +-

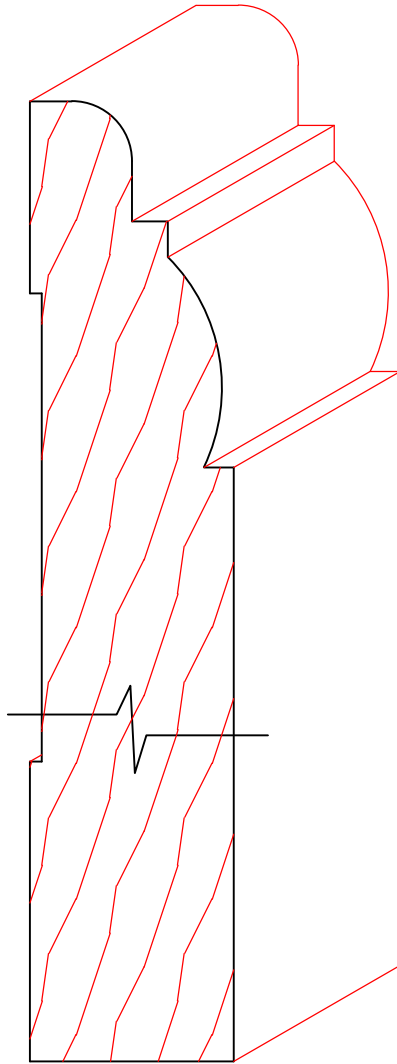

TM2074
1-1/16" X 5" +-

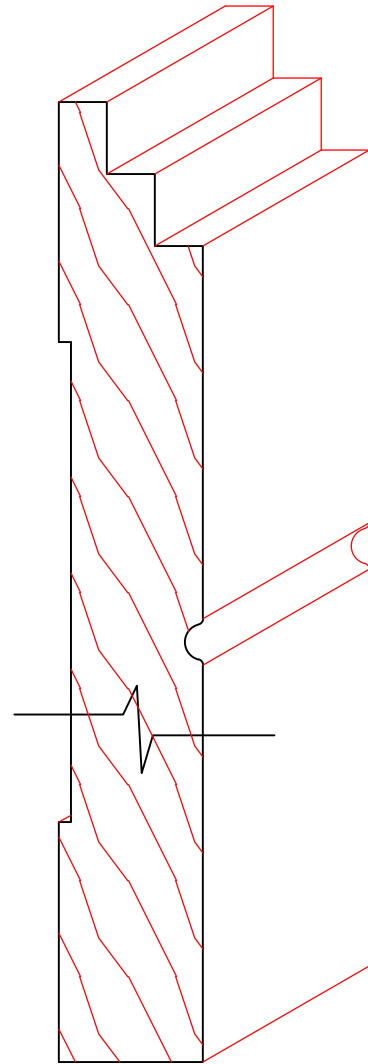

TM2075A
3/4" X 5" +-

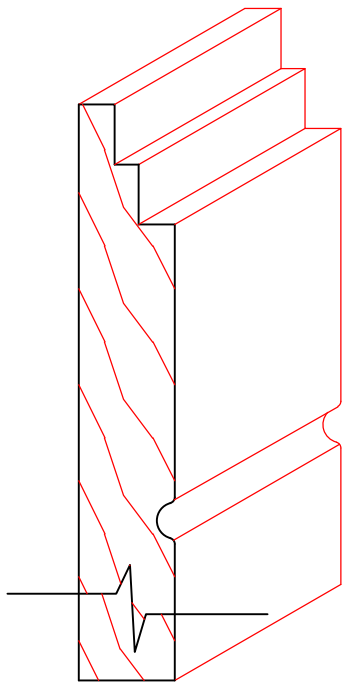

TM2075B
1/2" X 3" +-

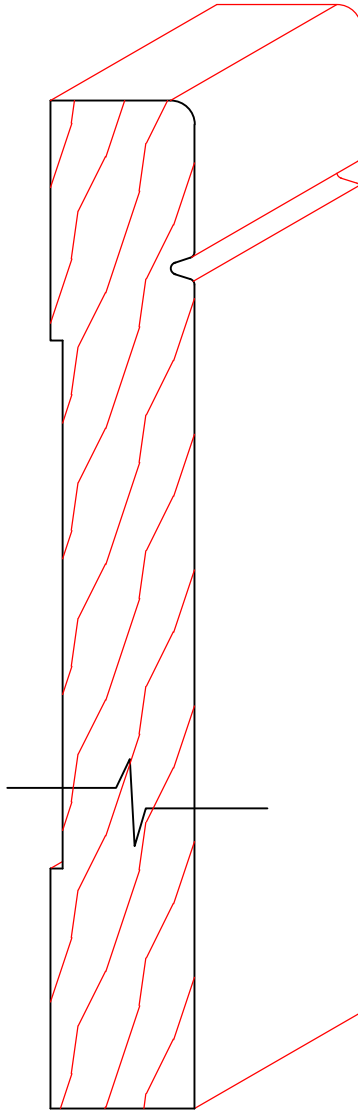

TM2076
3/4" X 5-1/4" +-

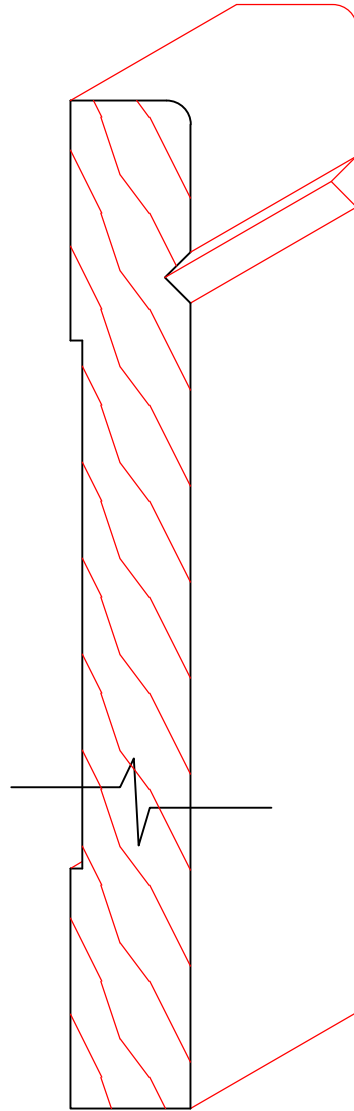

TM2077
5/8" X 5-1/4" +-

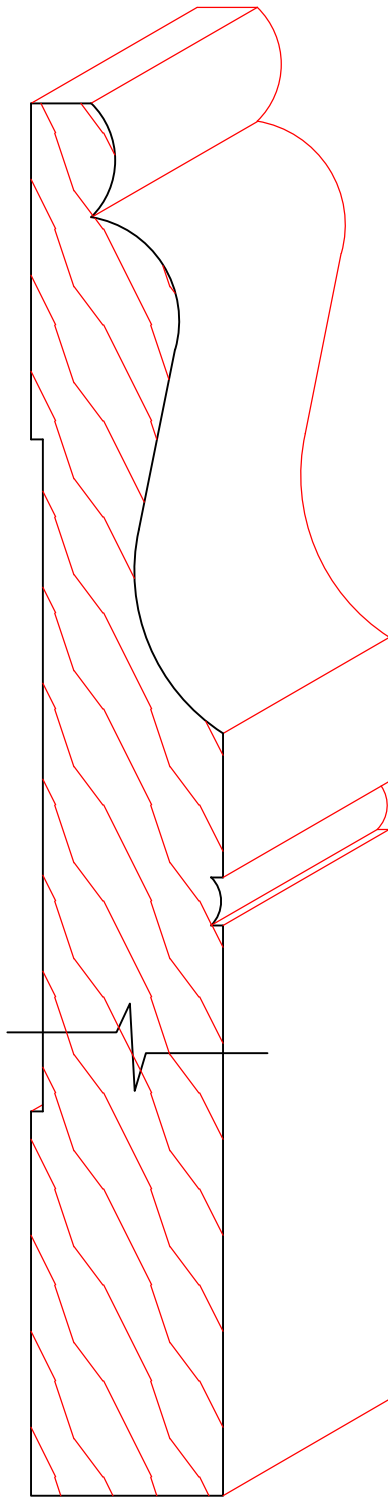

TM2078
1" X 7-1/4" +-

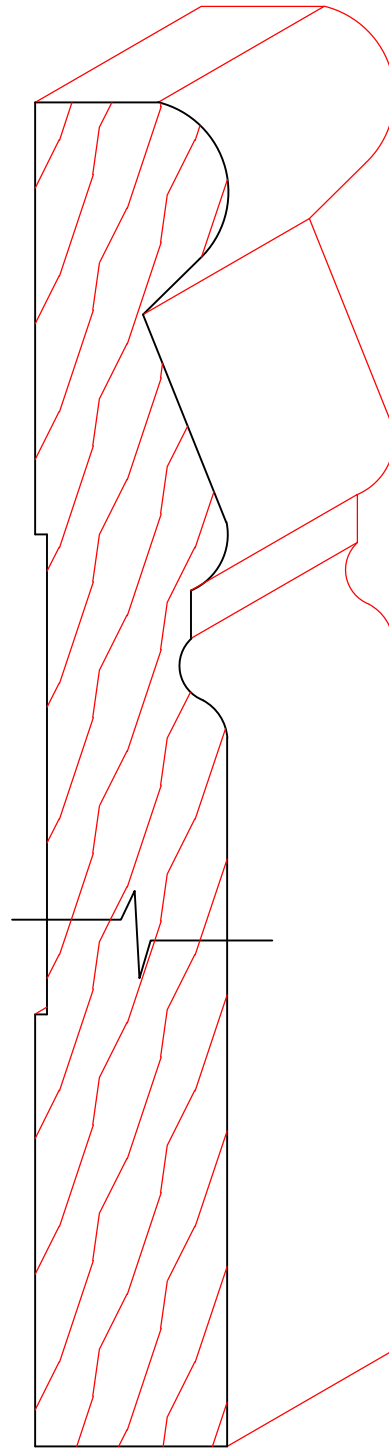

TM2079
1" X 7" +-

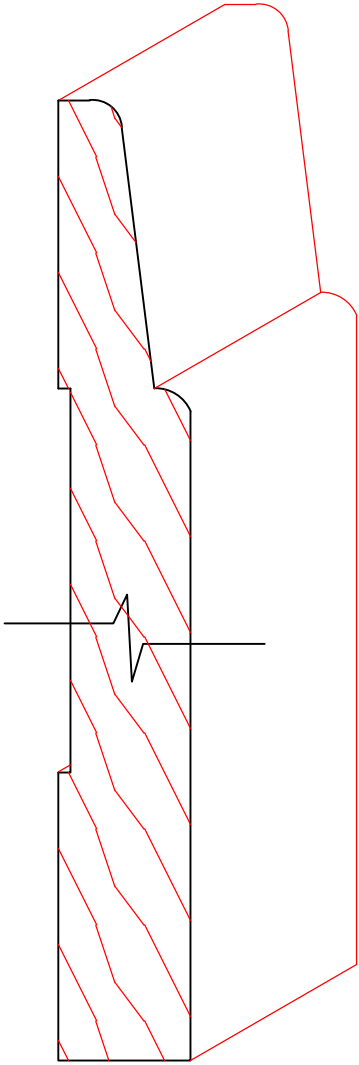

TM2080A
11/16" X 5" +-

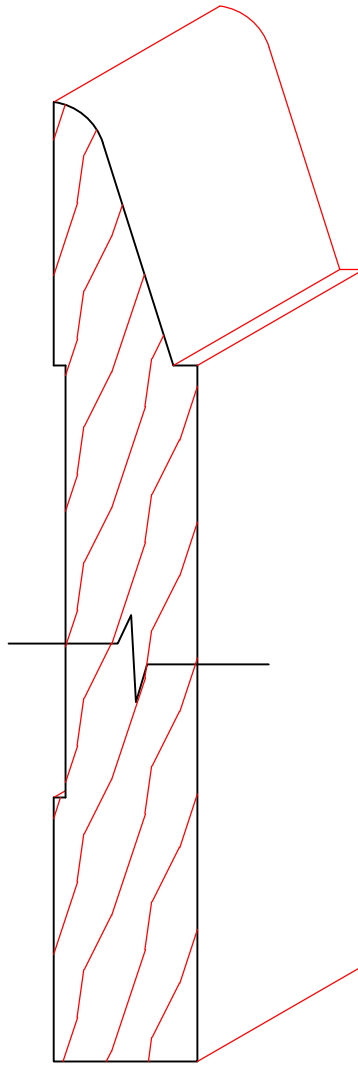

TM2080B
3/4" X 5" +-

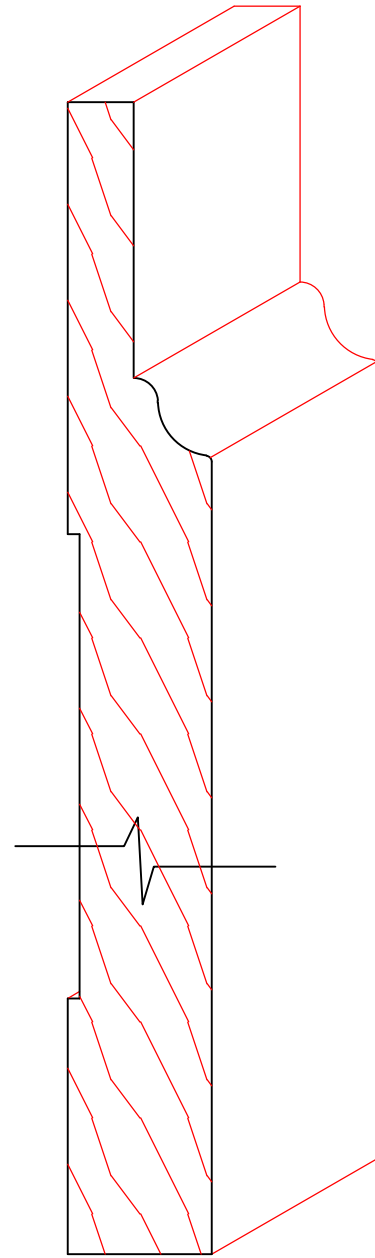

TM2081
3/4" X 6" +-

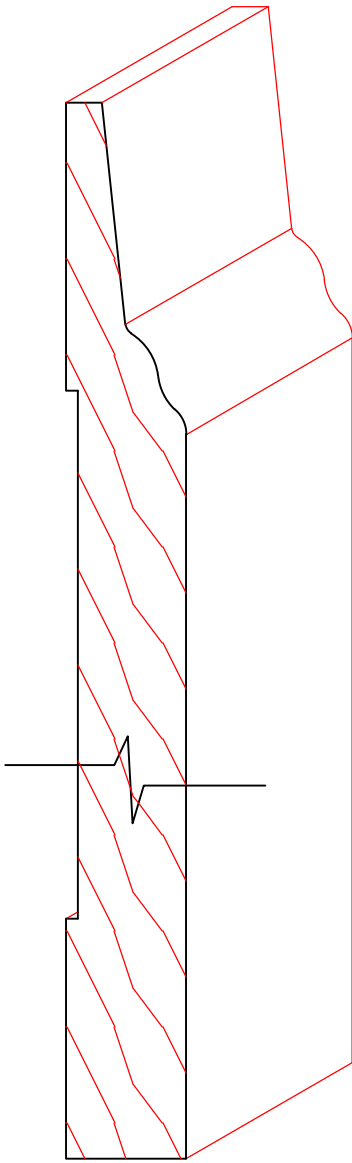

TM2082
5/8" X 5-1/2" +-

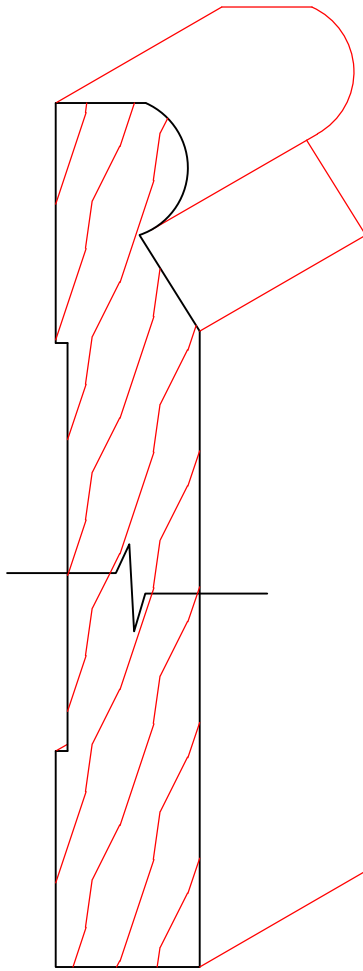

TM2083
3/4" X 4-1/2" +-

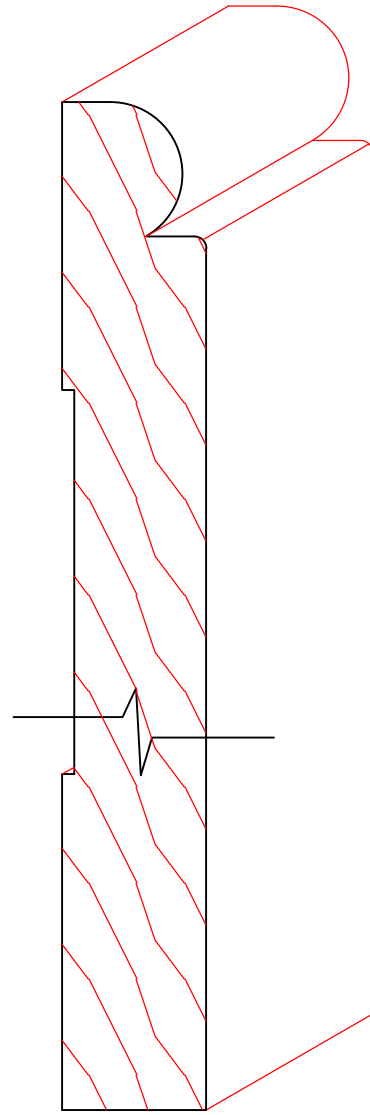

TM2084
3/4" X 5-1/4" +-

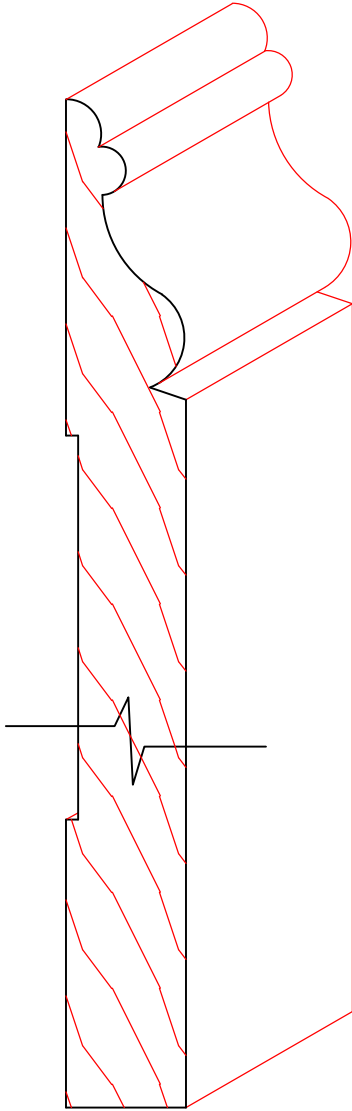

TM2085
5/8" X 5-1/4" +-

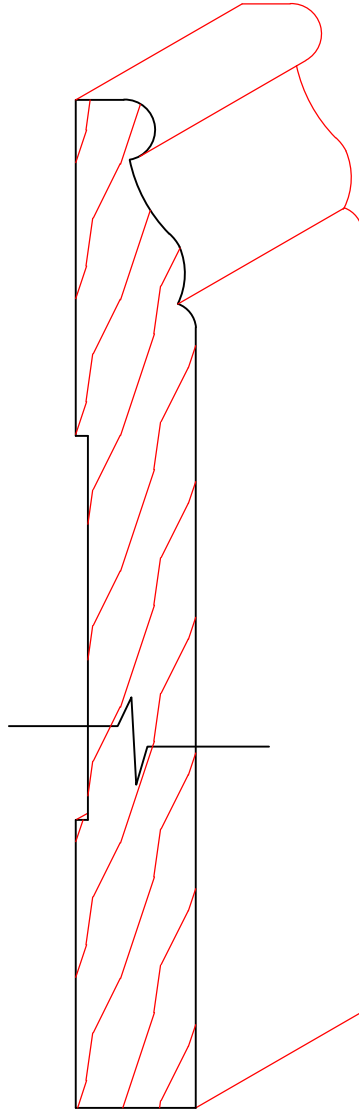

TM2086
5/8" X 5-1/4" +-

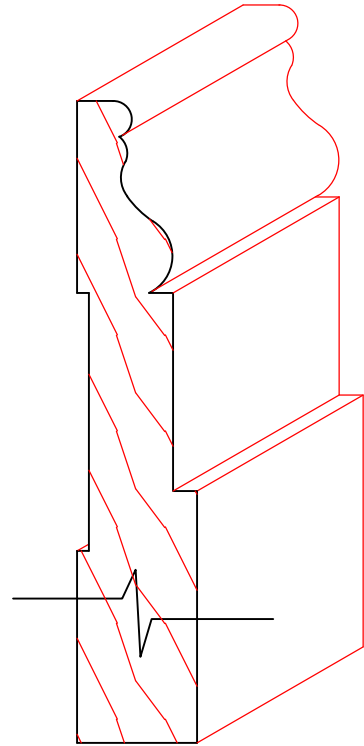

TM2087
5/8" X 3-3/8" +-



TM2088
3/4" X 5-1/4"

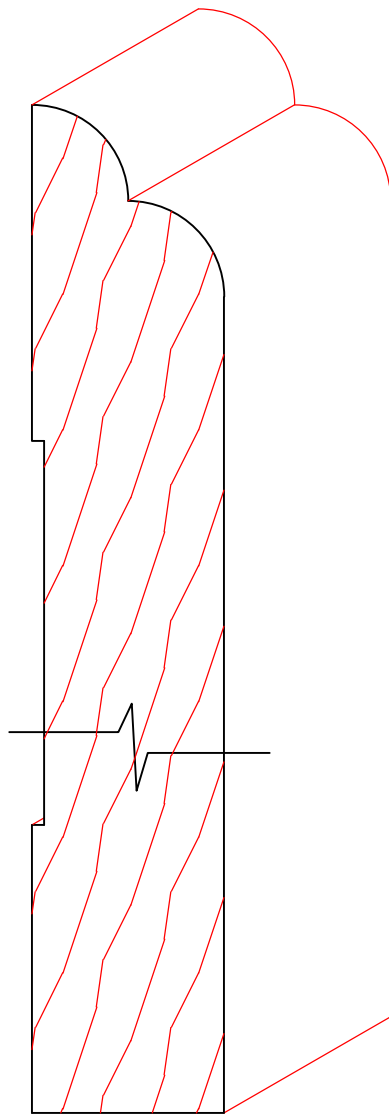

TM2089
1" X 5-1/4"±

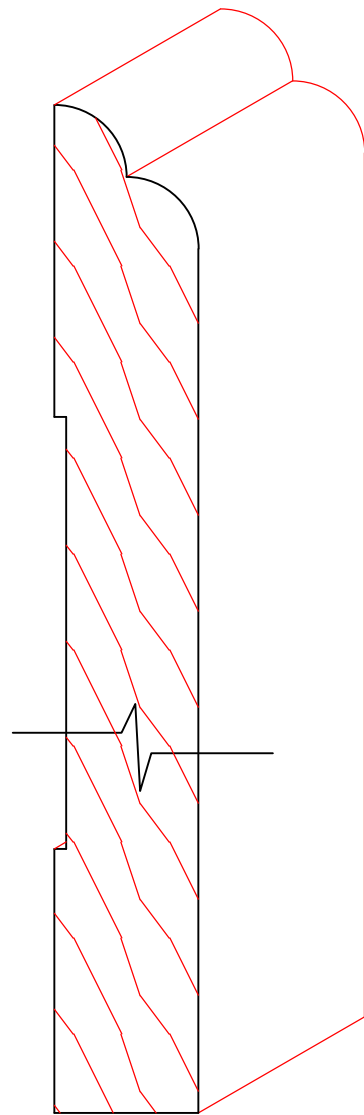

TM2090
3/4" X 5-1/4"±

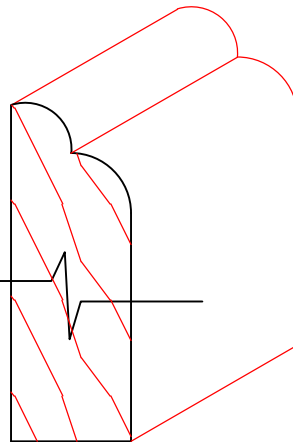

TM2091
5/8" X 1-3/4"±

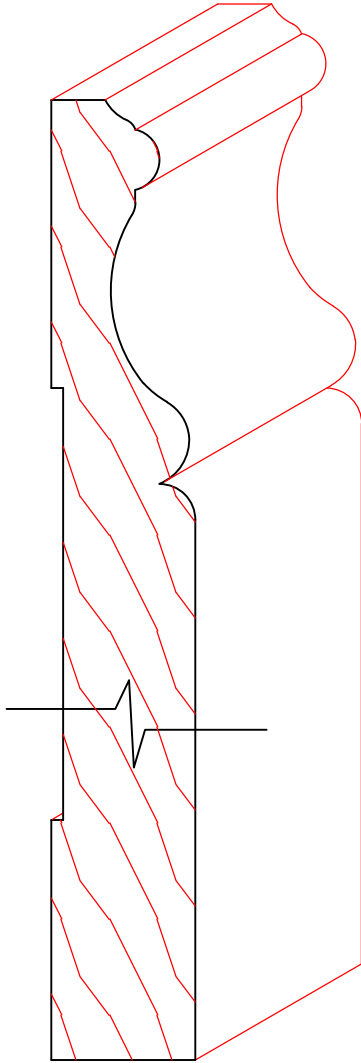

TM2092
3/4" X 5" +-

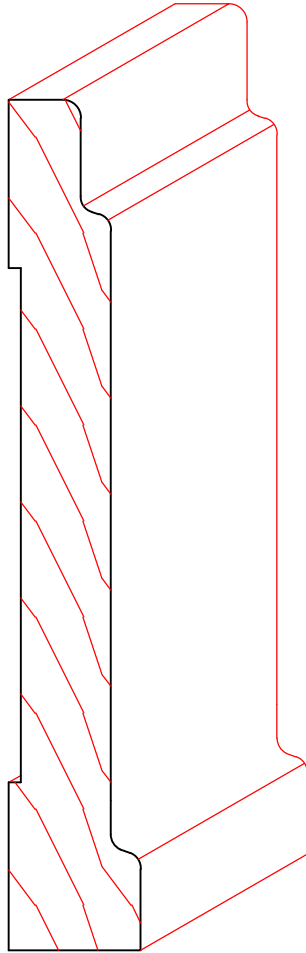

TM2093
11/16" X 4-1/2"

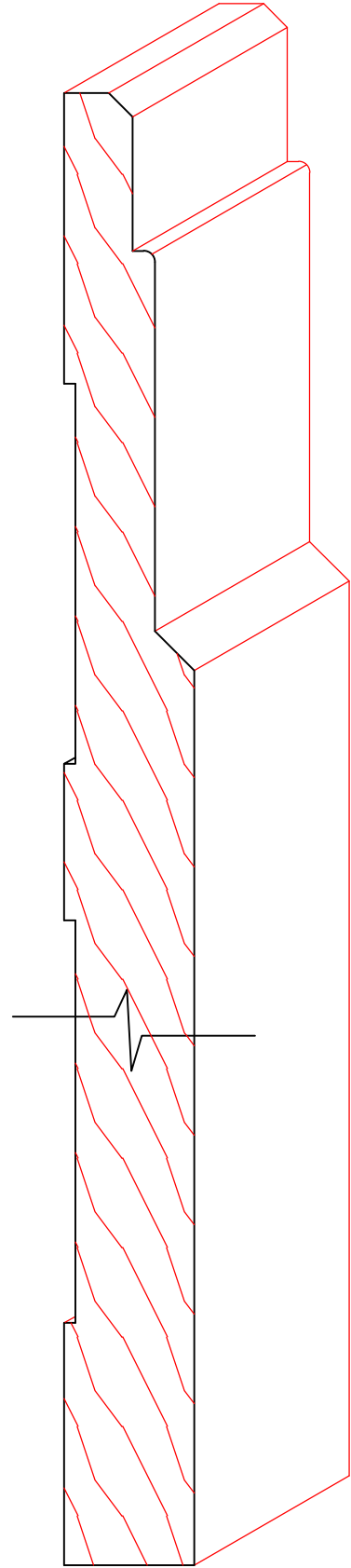

TM2094
3/4" X 8-1/4" +-

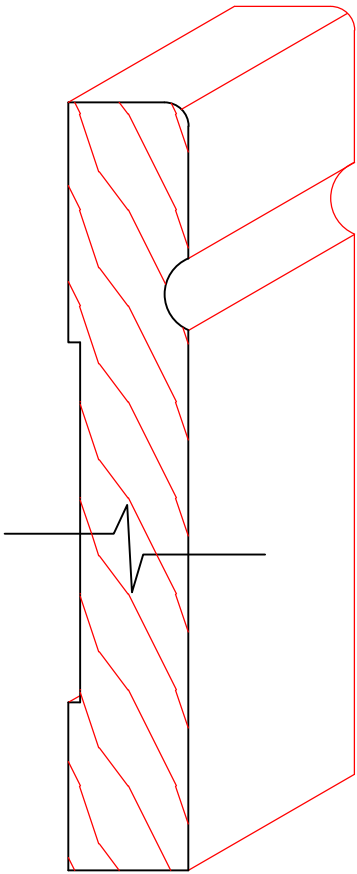

TM2095
5/8" X 4" +-

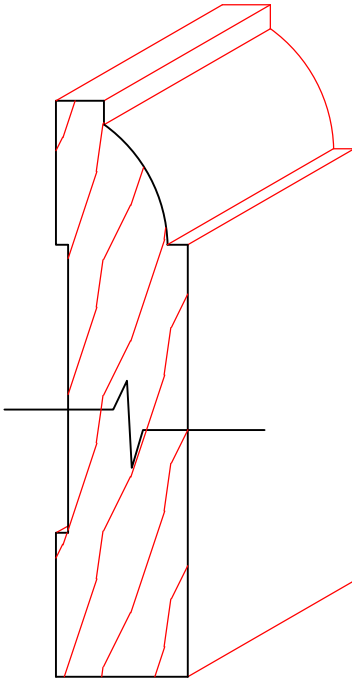

TM2096
11/16" X 3" +-

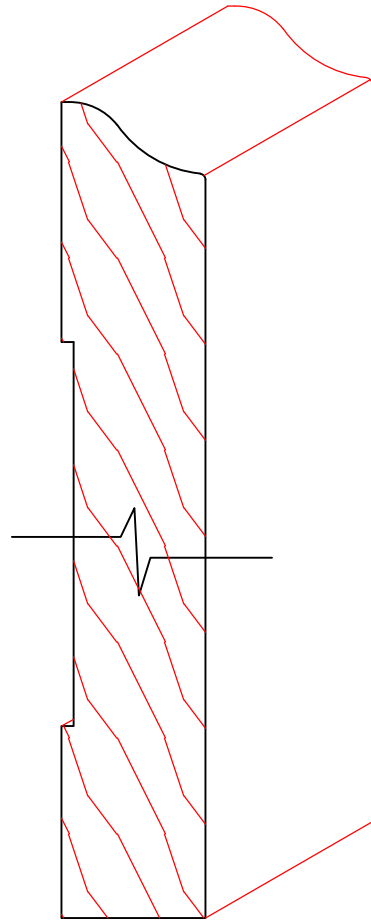

TM2097
3/4" X 4-1/4" +-

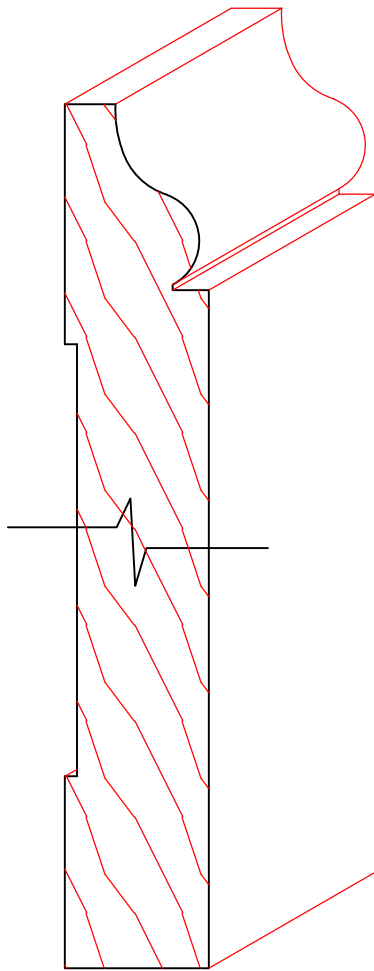

TM2098

3/4" X 4-1/2" +-

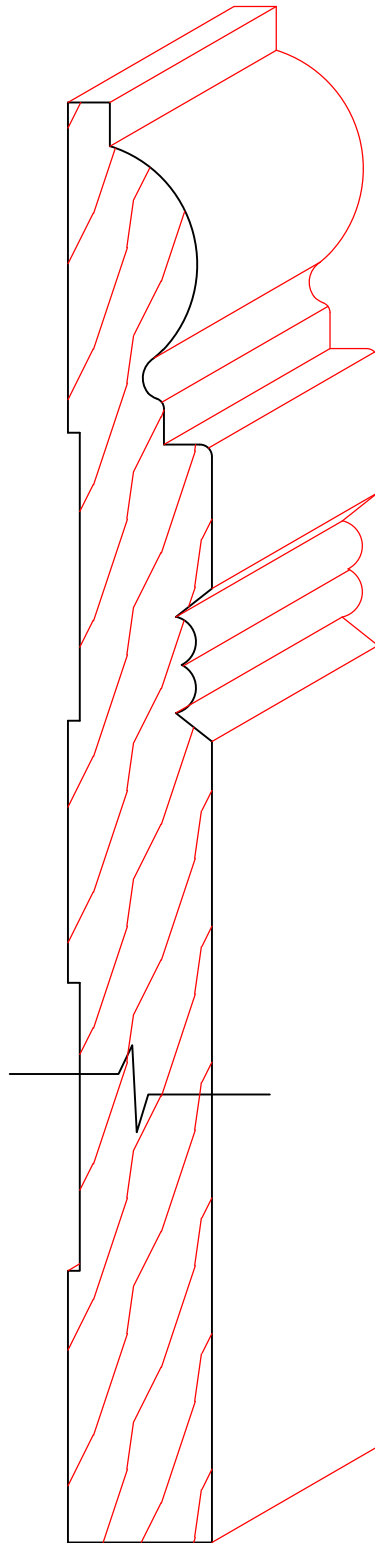

TM2099

3/4" X 7-1/2" +-

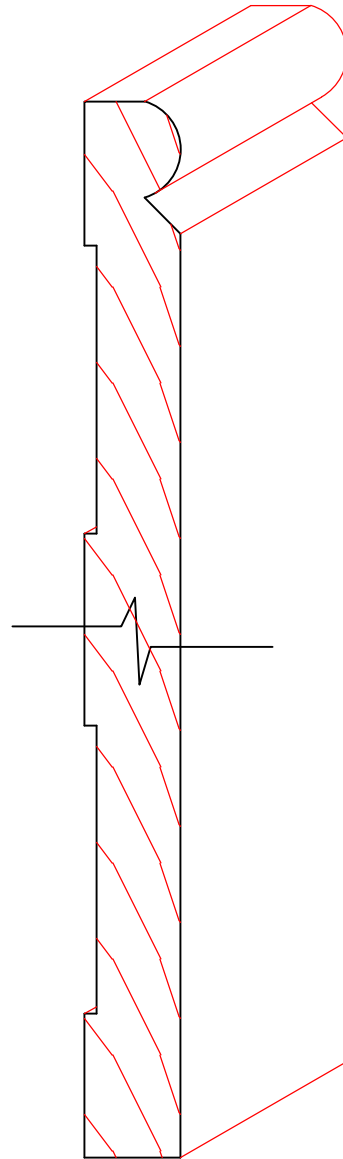

TM2100

1/2" X 5-1/2" +-

THOMAS AND MILLIKEN MILLWORK, INC.

**FULL
SCALE**

33

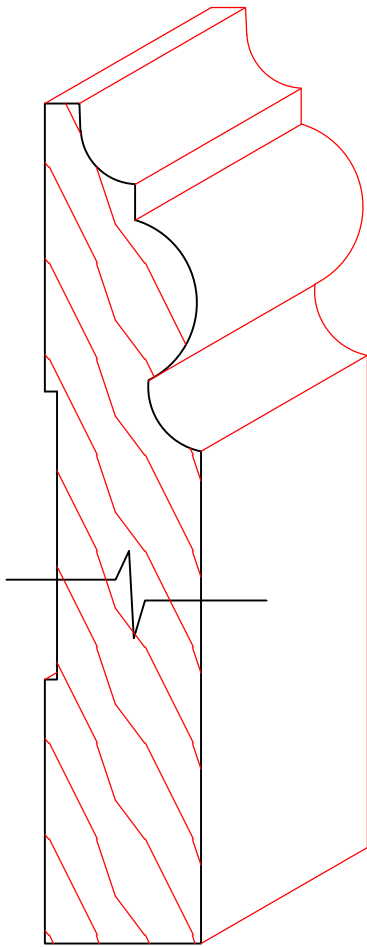

TM2101

13/16" X 4-3/8" +-

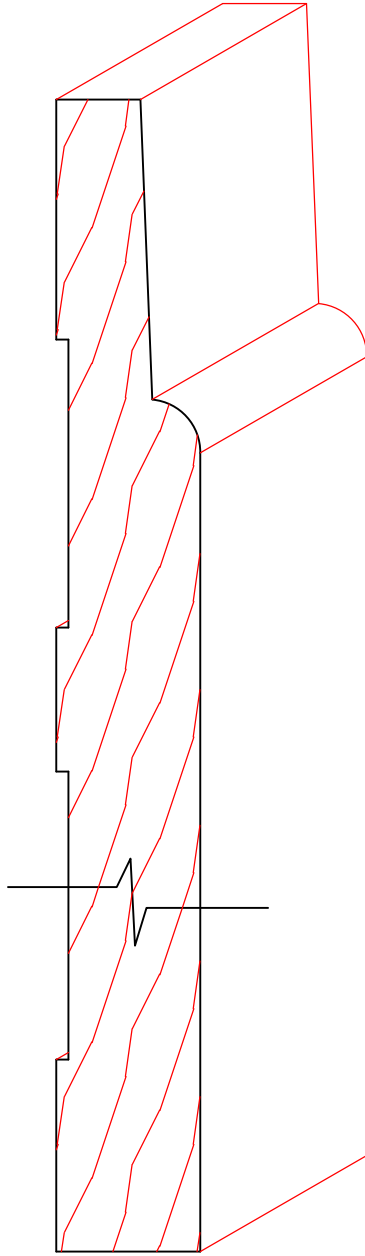

TM2102

3/4" X 6" +-

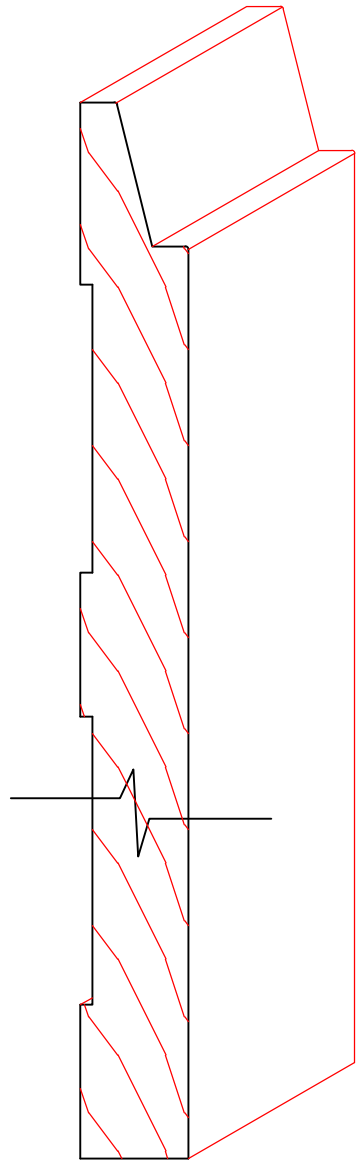

TM2103

9/16" X 5-1/2" +-

THOMAS AND MILLIKEN MILLWORK, INC.

FULL
SCALE

34

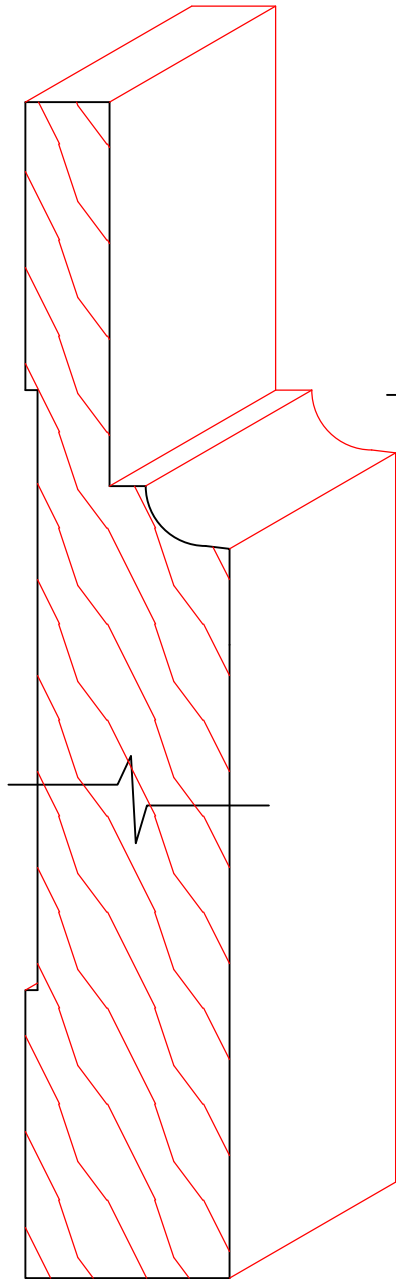

TM2104

1-1/16" X 6-1/8" +-

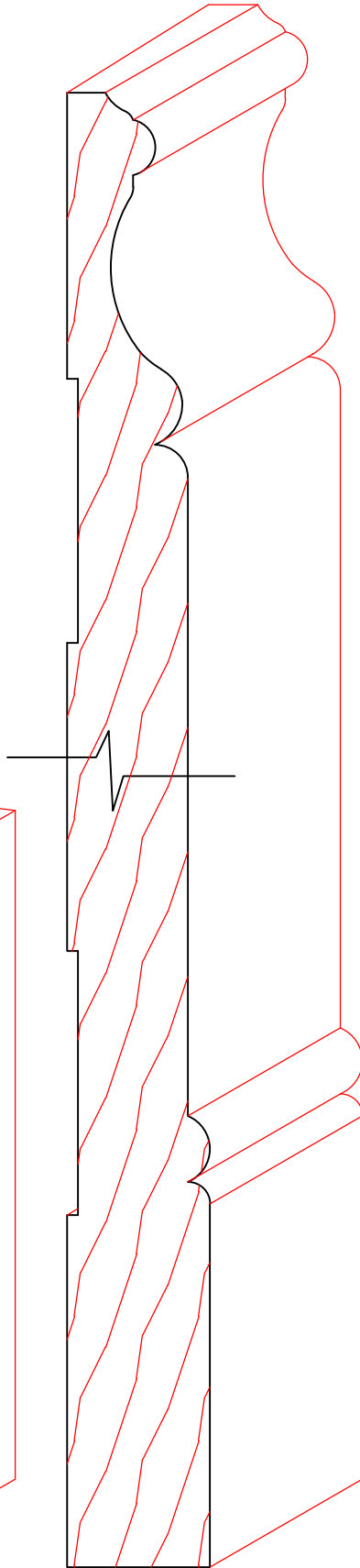

TM2105

13/16" X 8-3/8" +-

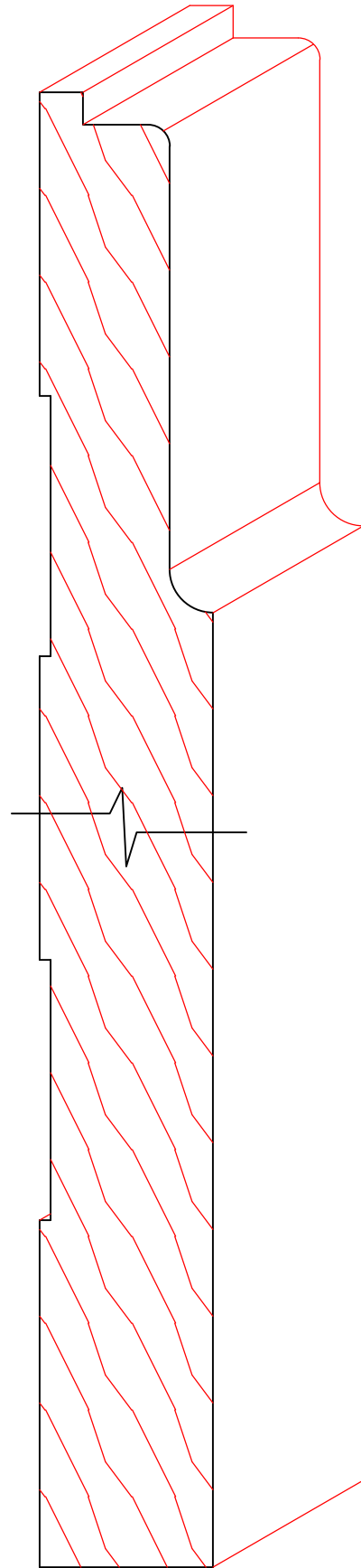

TM2106

1" X 8-1/2" +-

THOMAS AND MILLIKEN MILLWORK, INC.

FULL
SCALE

35

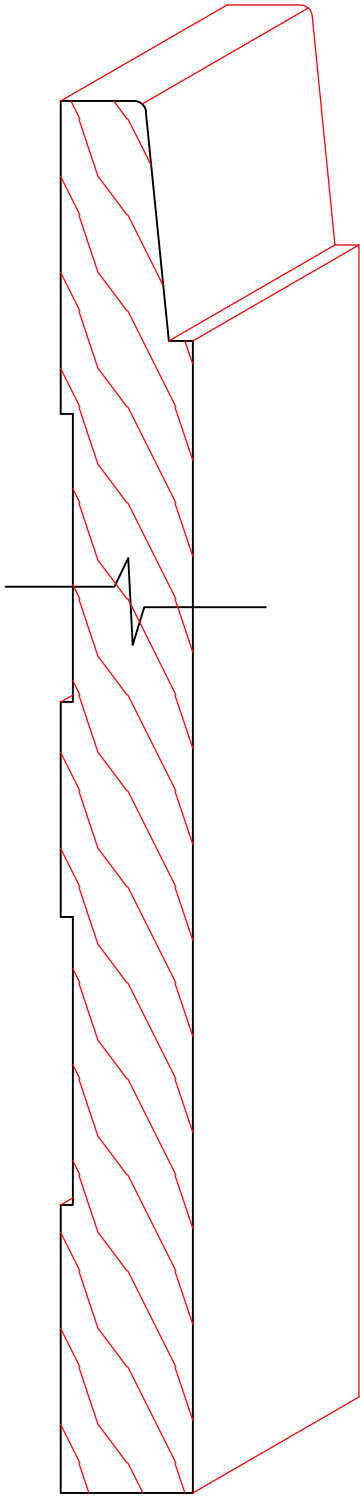

TM2107
11/16" X 7-1/4" +-

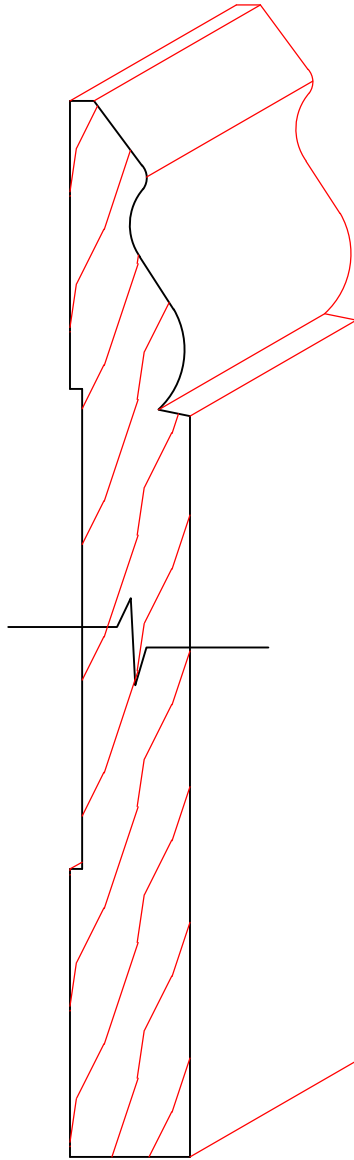

TM2108
5/8" X 5-1/2" +-

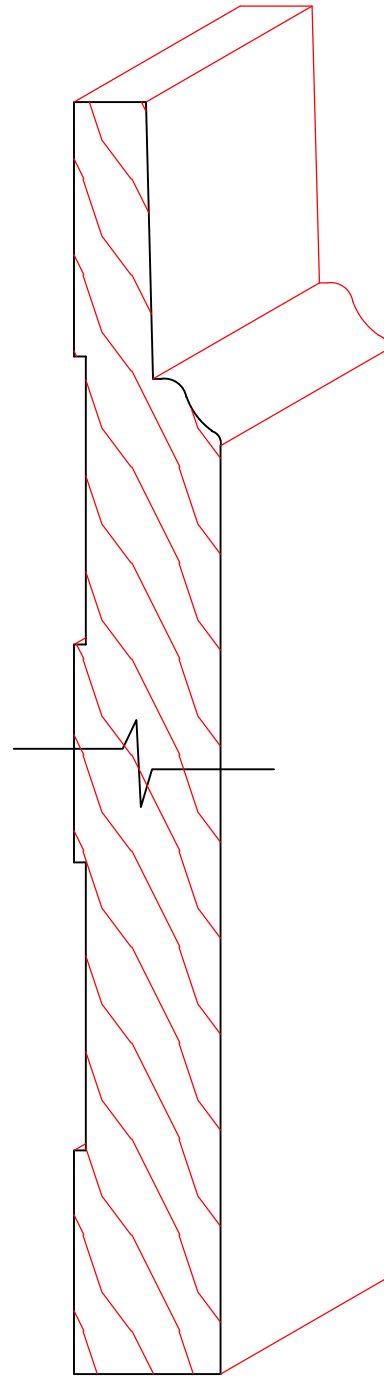

TM2109
3/4" X 6-5/8" +-

THOMAS AND MILLIKEN MILLWORK, INC.

FULL
SCALE

36

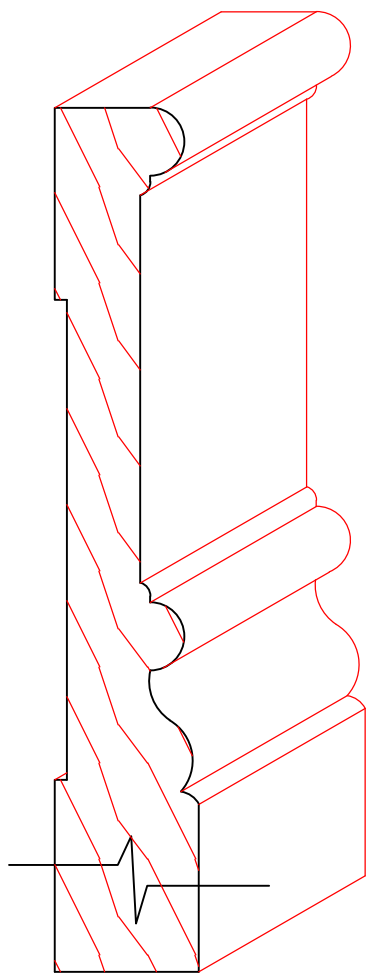

TM2110
3/4" X 4-1/2" +-

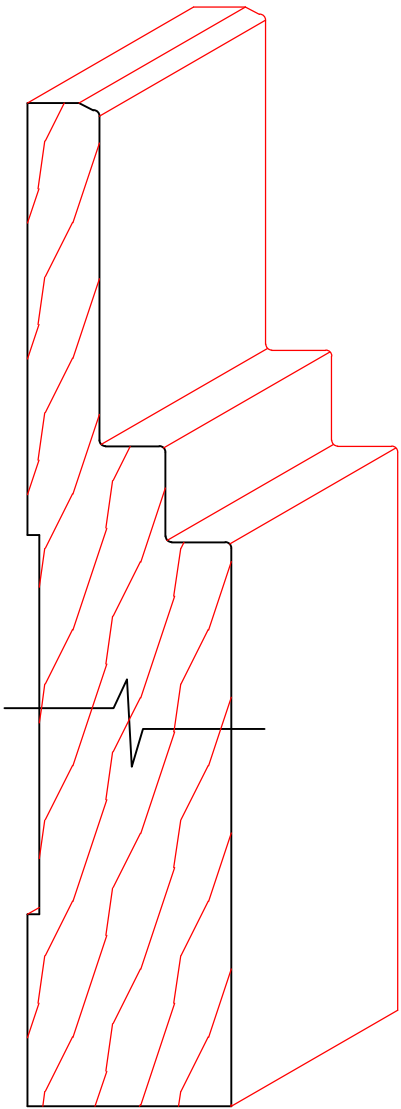

TM2111
1-1/16" X 5-1/4" +-

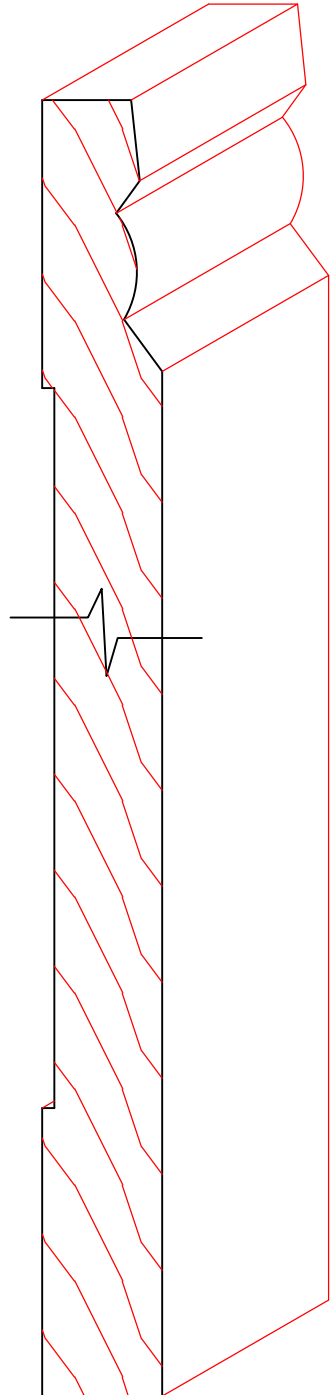

TM2112
5/8" X 6-3/4" +-

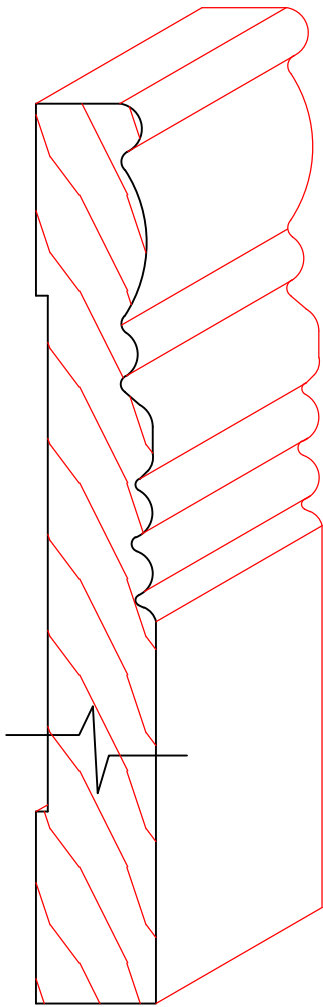

TM2113
5/8" X 4-11/16" +-

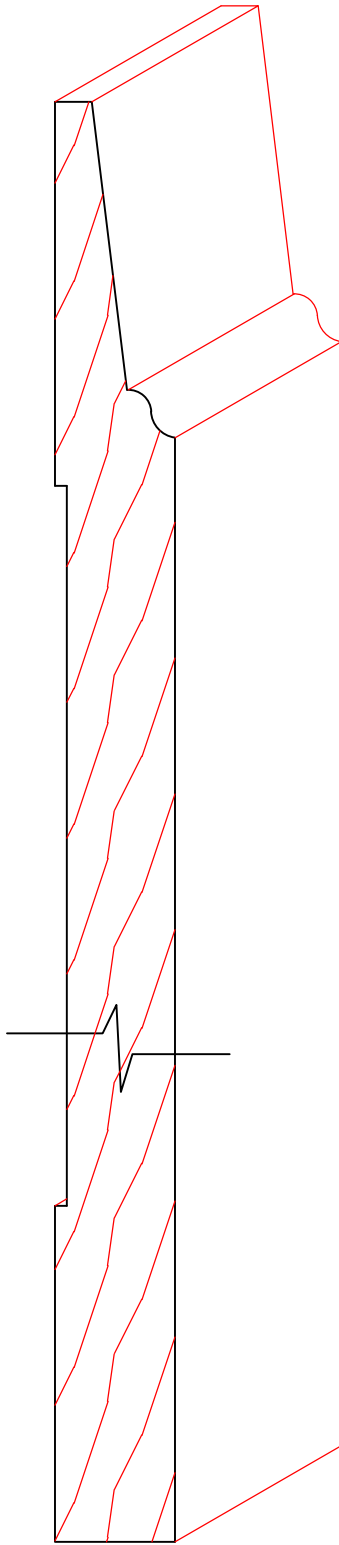

TM2114
5/8" X 7-1/2" +-

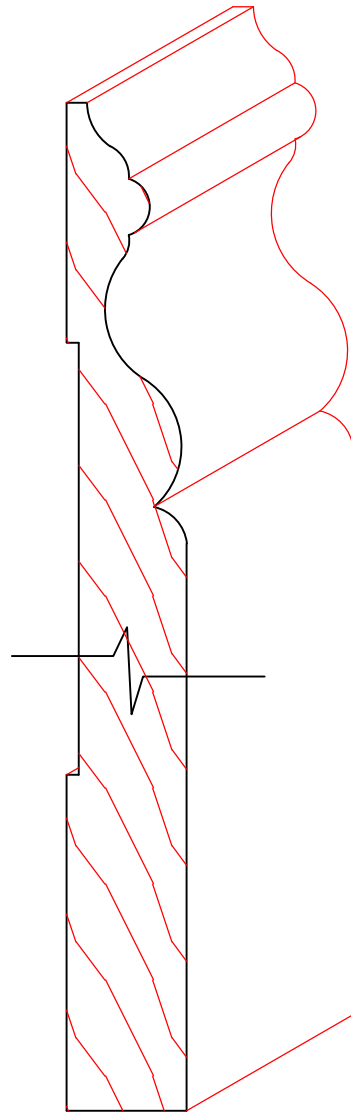

TM2115
5/8" X 5-1/4" +-

THOMAS AND MILLIKEN MILLWORK, INC.

FULL
SCALE

38

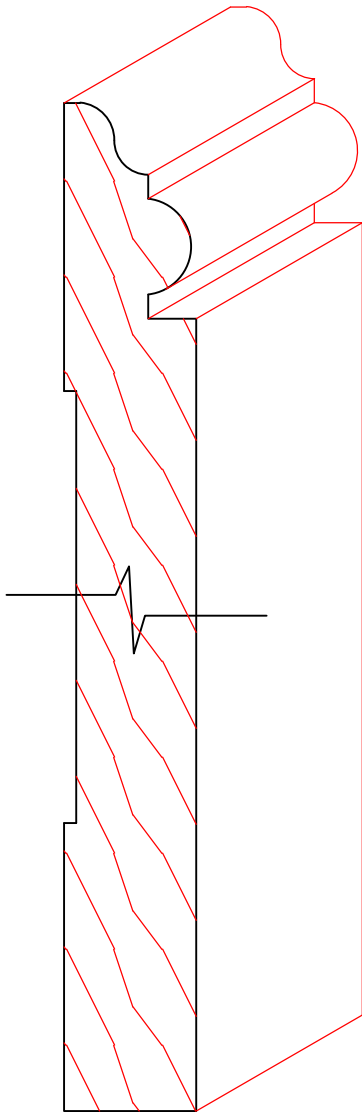

TM2116
11/16" X 5-1/4" +-

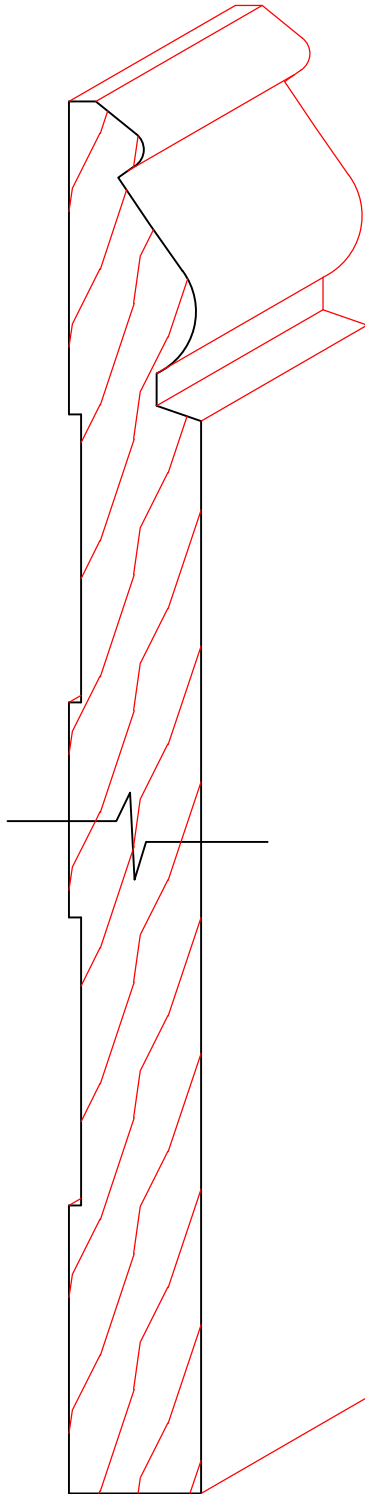

TM2117
11/16" X 7-1/4" +-

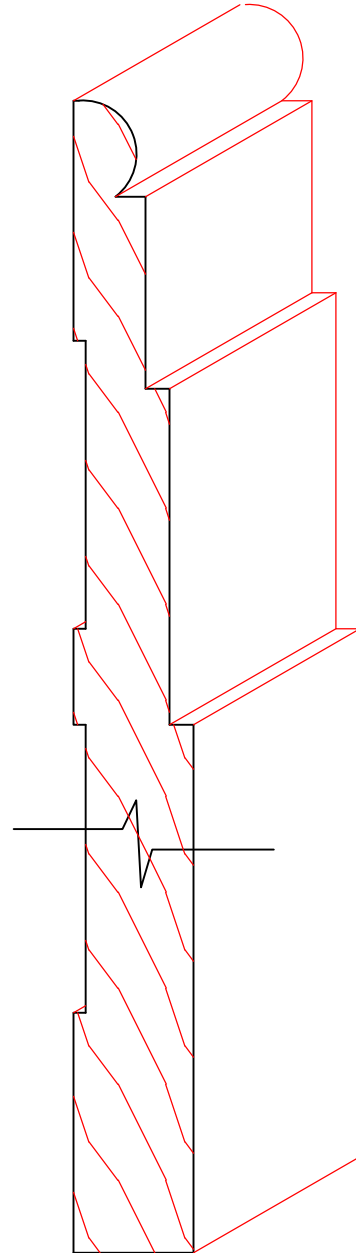

TM2118
5/8" X 6" +-

THOMAS AND MILLIKEN MILLWORK, INC.

FULL
SCALE

39



TM2119
5/8" X 5" +-

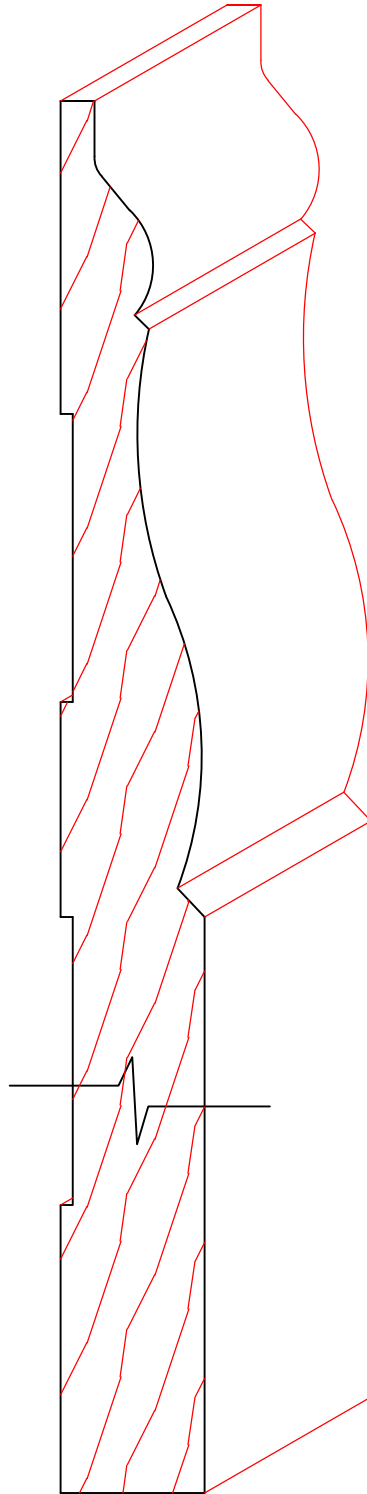

TM2120
3/4" X 7-1/4" +-

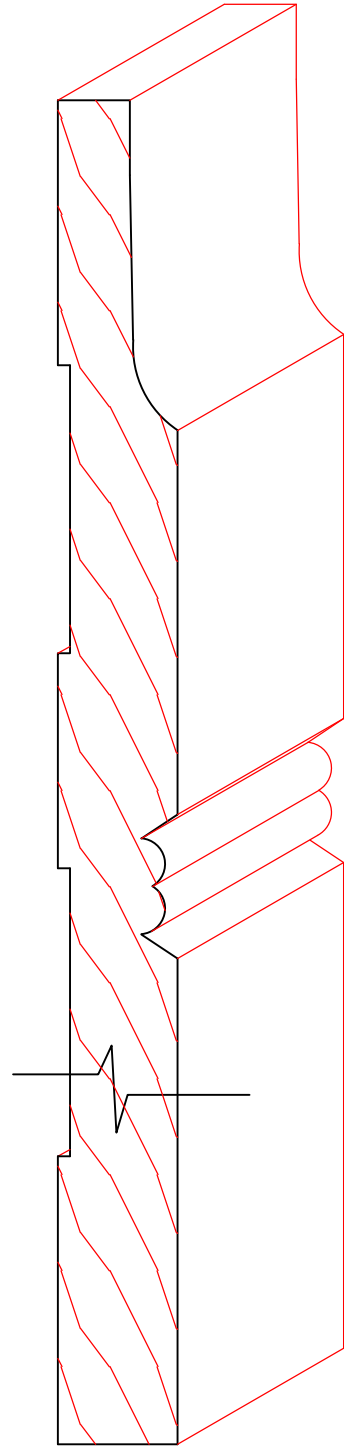

TM2121
5/8" X 7" +-

THOMAS AND MILLIKEN MILLWORK, INC.

FULL
SCALE

40

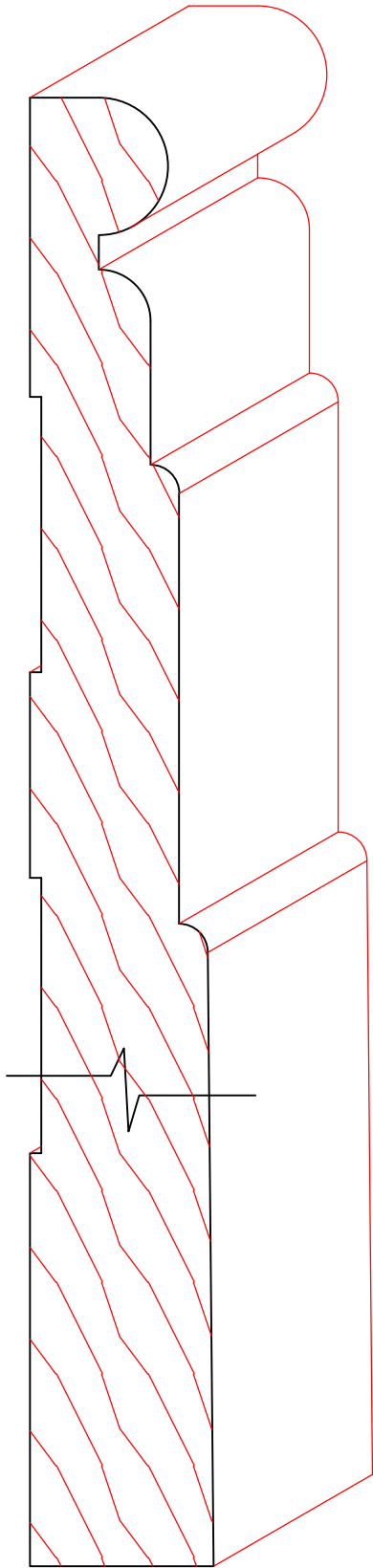

TM2122
1" X 8" +-

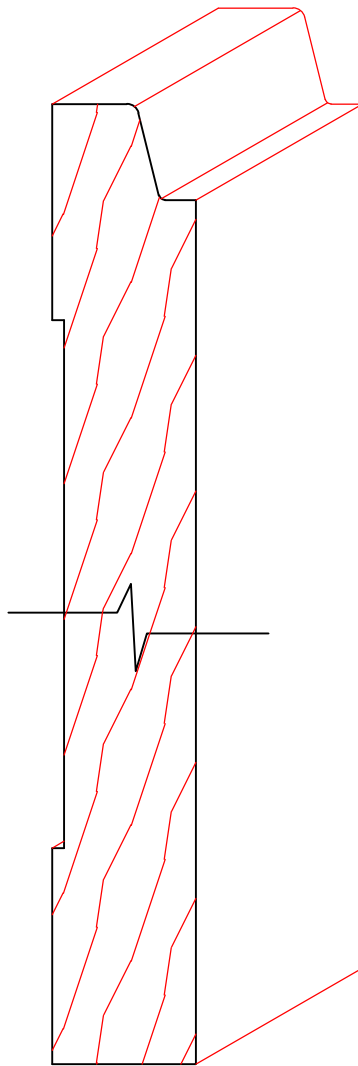

TM2123
3/4" X 5" +-

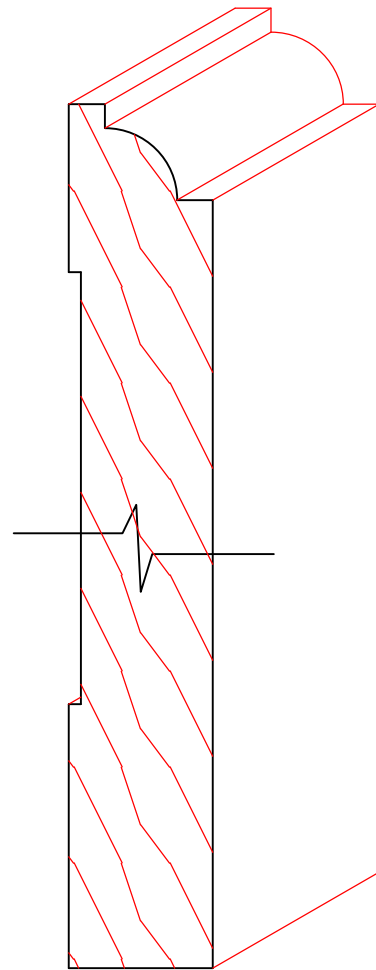

TM2124
3/4" X 4-1/2" +-

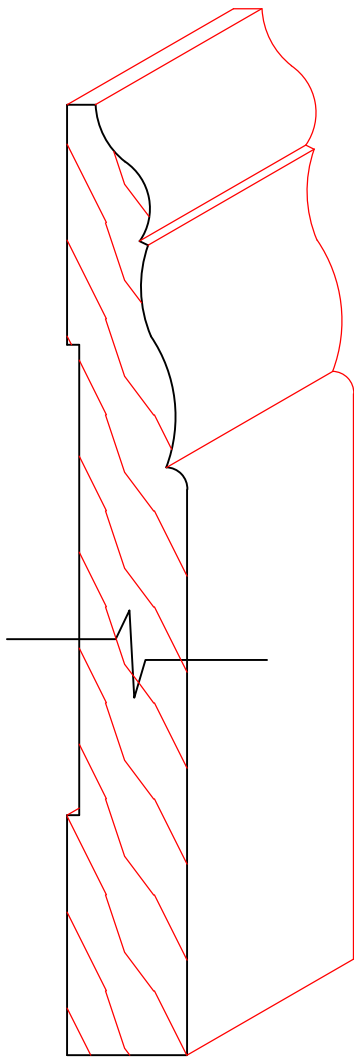

TM2125
5/8" X 4-15/16" +-

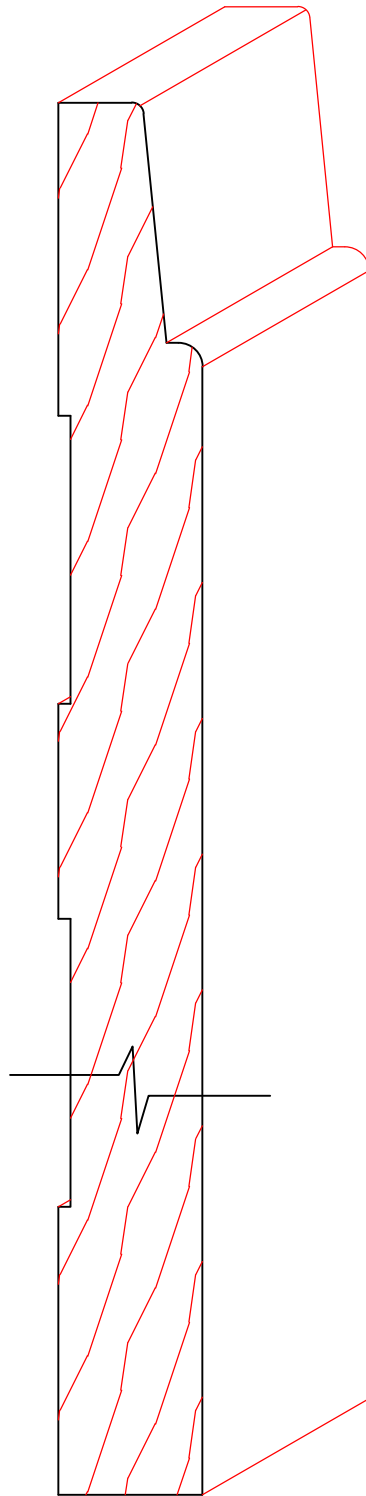

TM2126
3/4" X 7-1/4" +-

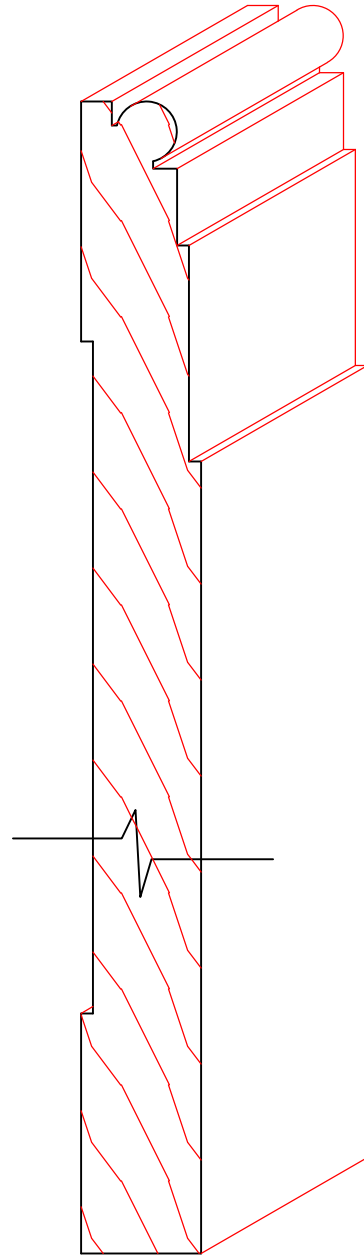

TM2127
5/8" X 6" +-

THOMAS AND MILLIKEN MILLWORK, INC.

FULL
SCALE

42

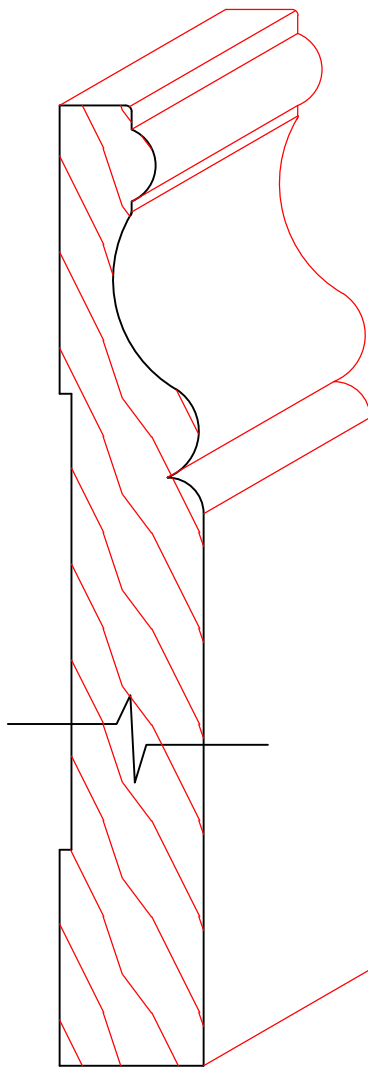

TM2128
3/4" X 5" +-

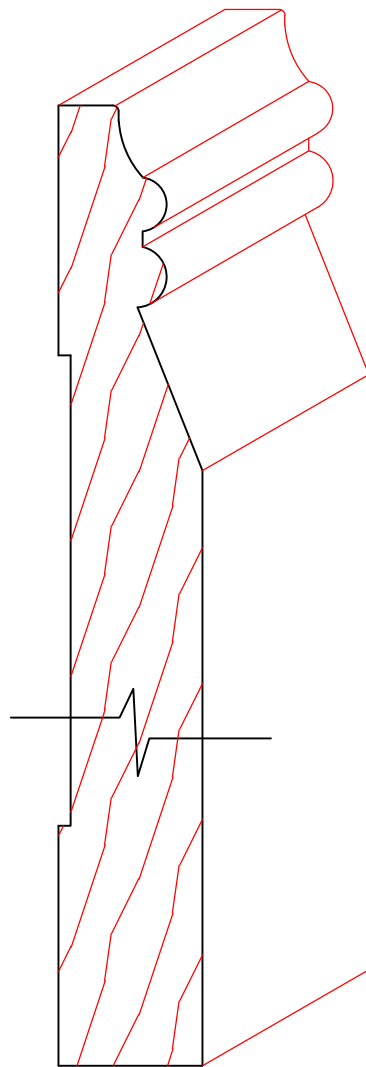

TM2129
3/4" X 5" +-

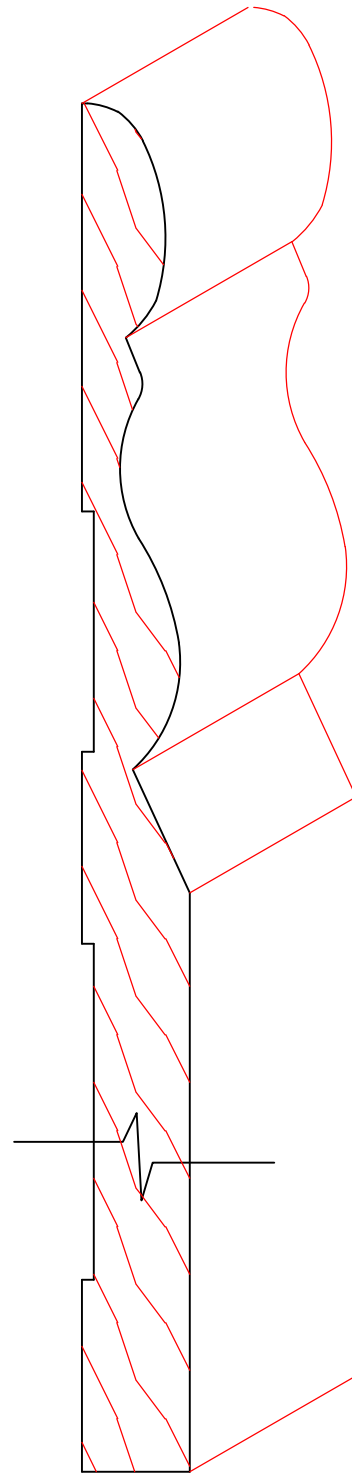

TM2130
9/16" X 7-1/8" +-

THOMAS AND MILLIKEN MILLWORK, INC.

FULL
SCALE

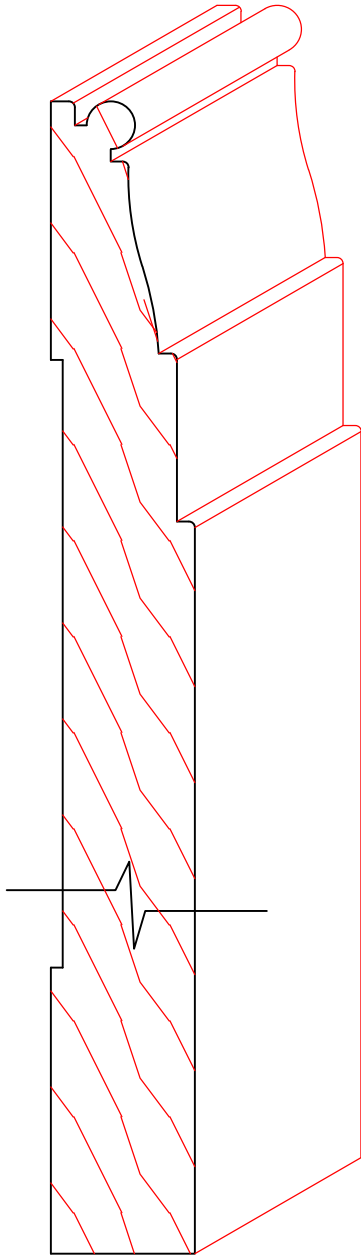

TM2131
3/4" X 6" +-

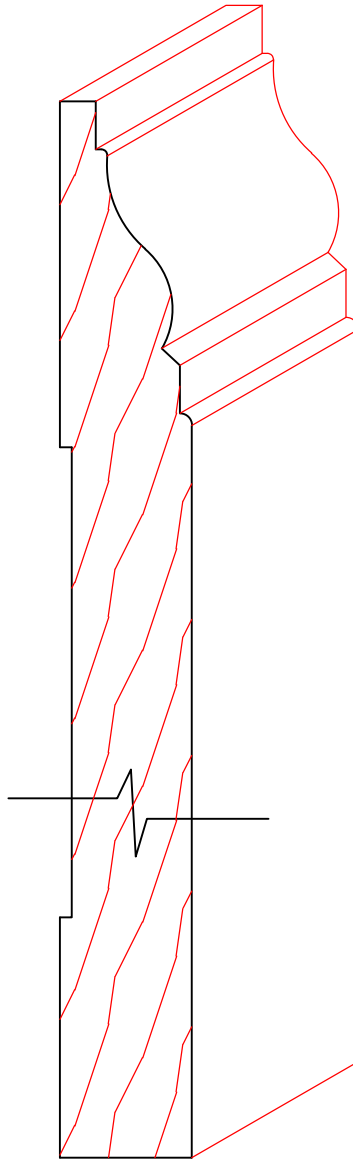

TM2132
11/16" X 5-1/2" +-

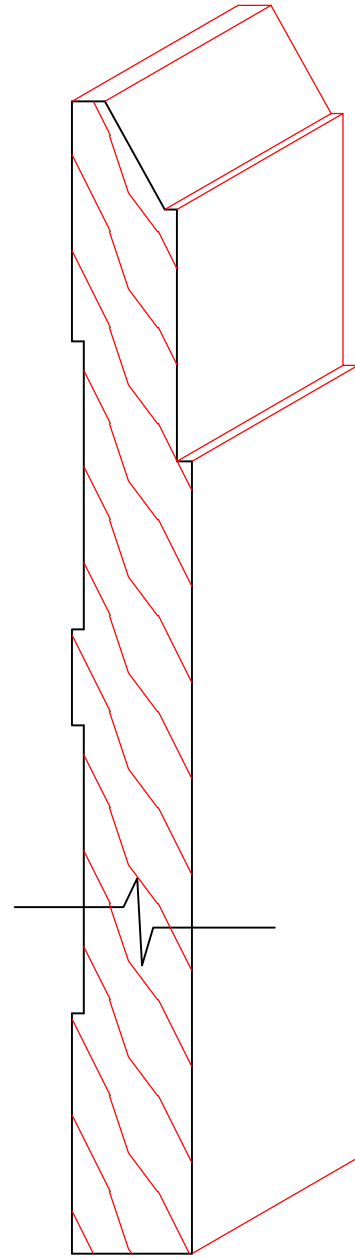

TM2133
5/8" X 6" +-

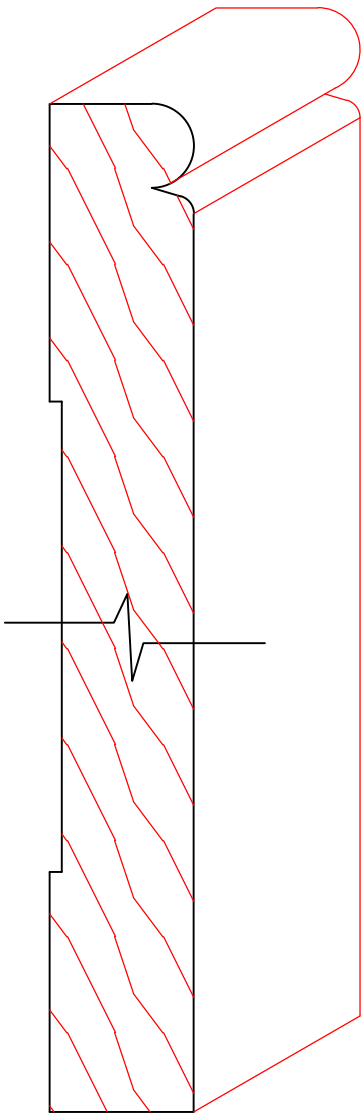

TM2134
3/4" X 5-1/4" +-

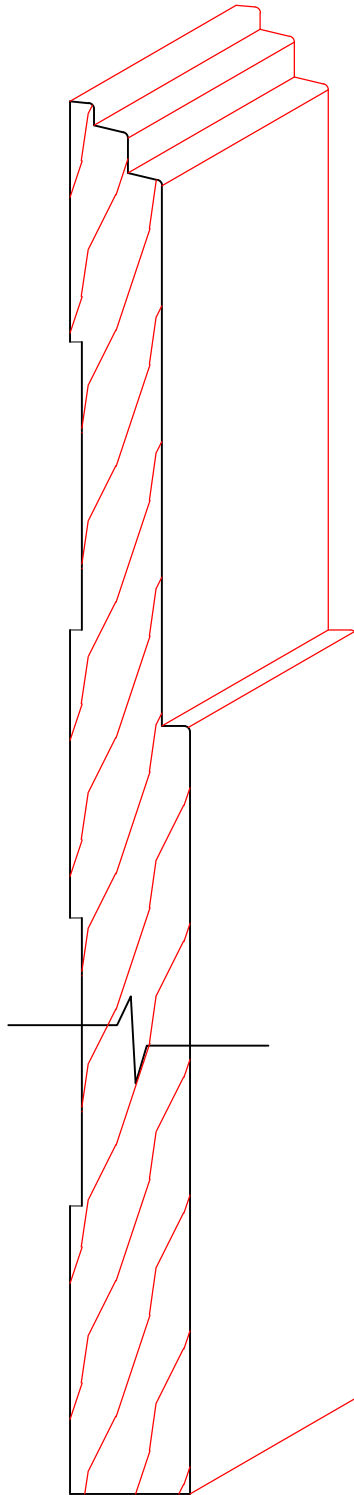

TM2135
5/8" X 7-1/4" +-

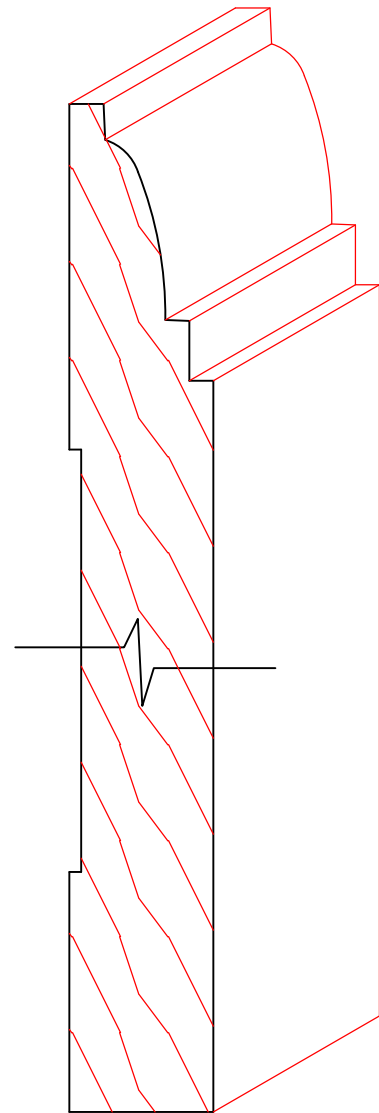

TM2136
3/4" X 5-1/4" +-

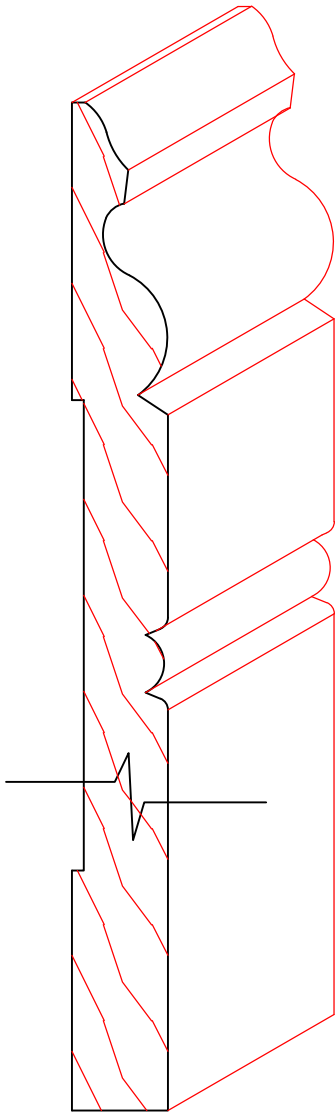

TM2137
1/2" X 5-1/4" +-

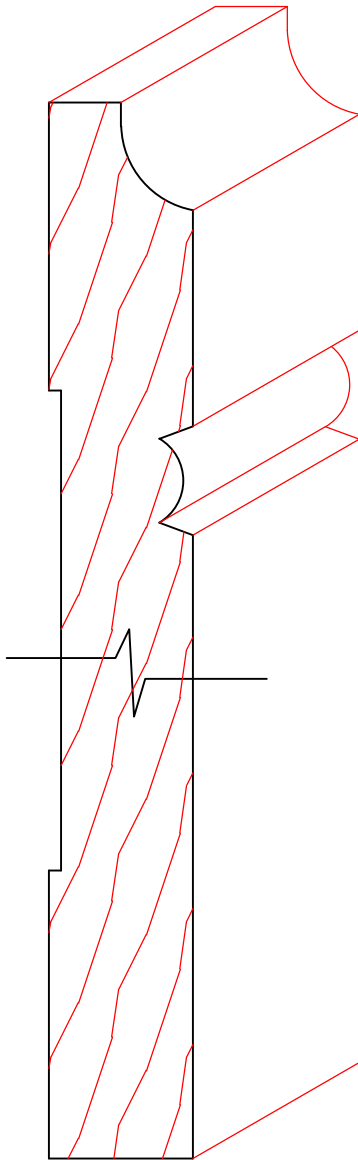

TM2138
3/4" X 5-1/2" +-

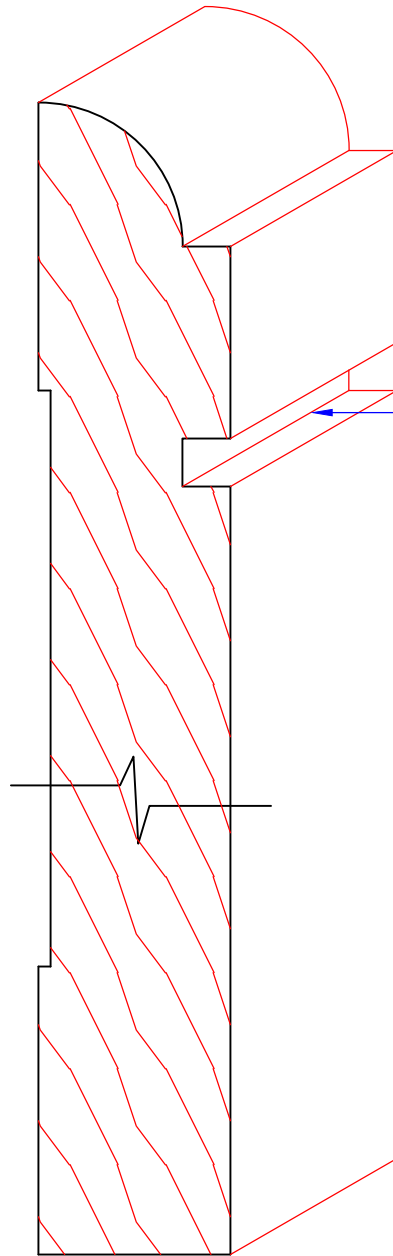

TM2139
1" X 6" +-
PLACE INLAY HERE

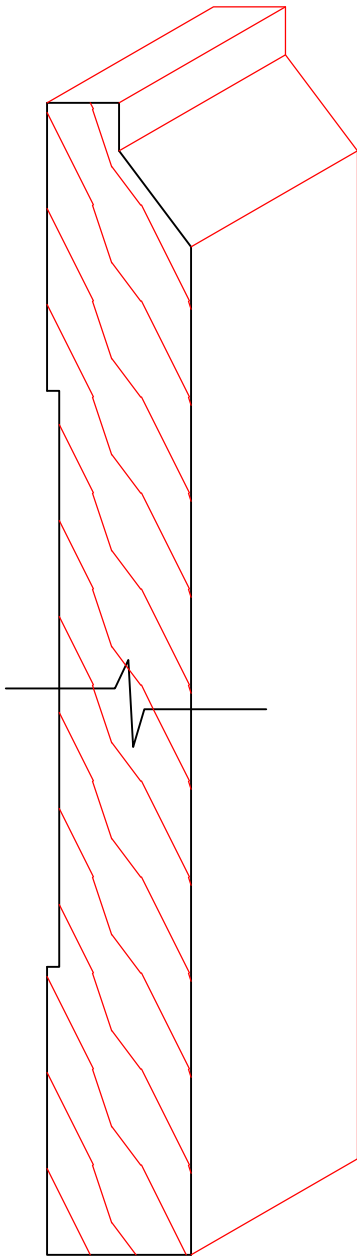

TM2140
3/4" X 6" +-



TM2141
1" X 10" +-

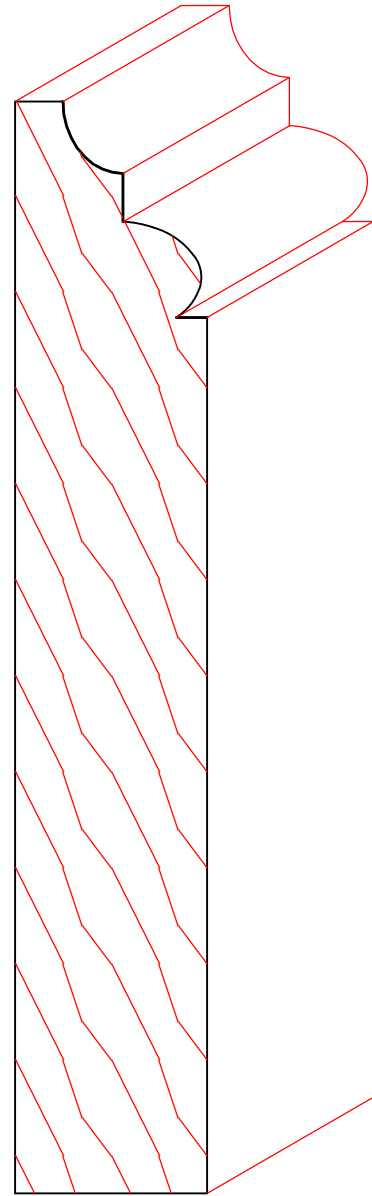

TM2142
1" X 5" +-

THOMAS AND MILLIKEN MILLWORK, INC.

FULL
SCALE

47

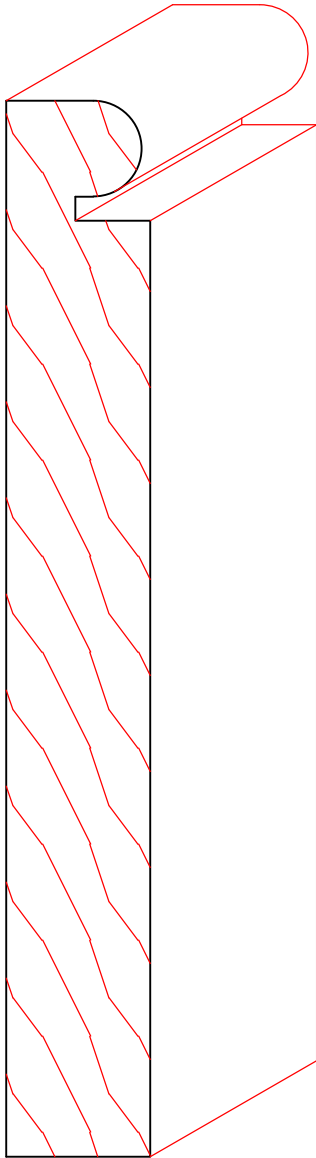

TM2143
3/4" X 5-1/2" +-

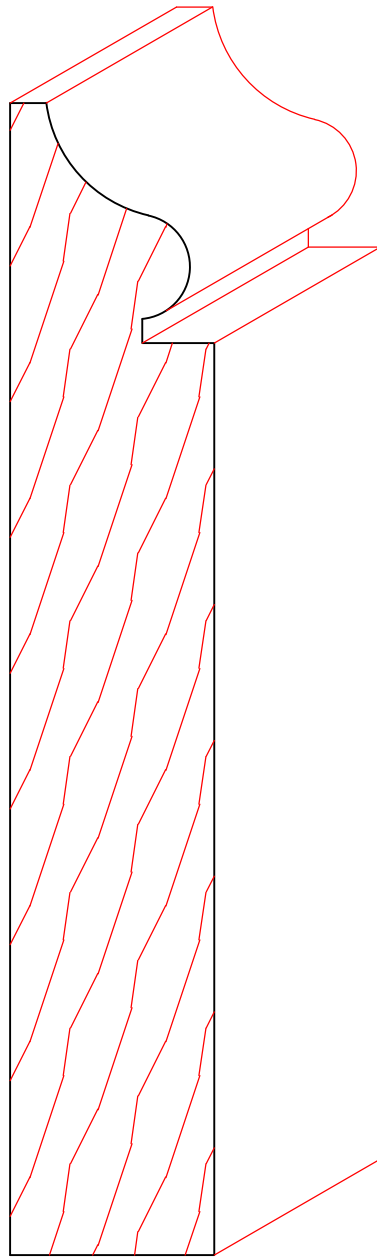

TM2144
1-1/16" X 6" +-



TM2145
1" X 8" +-

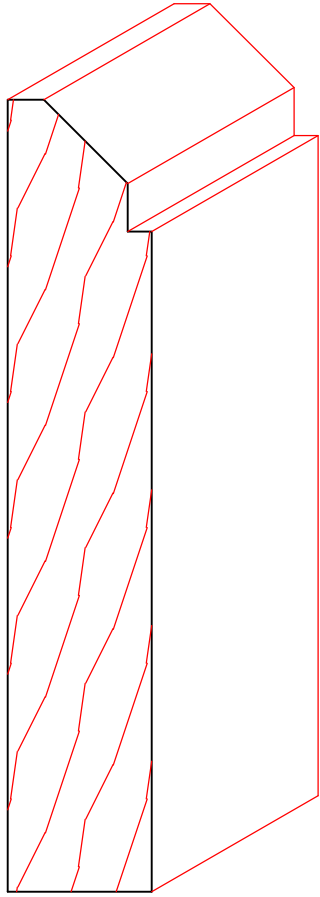

TM2146
3/4" X 4-1/8" +-

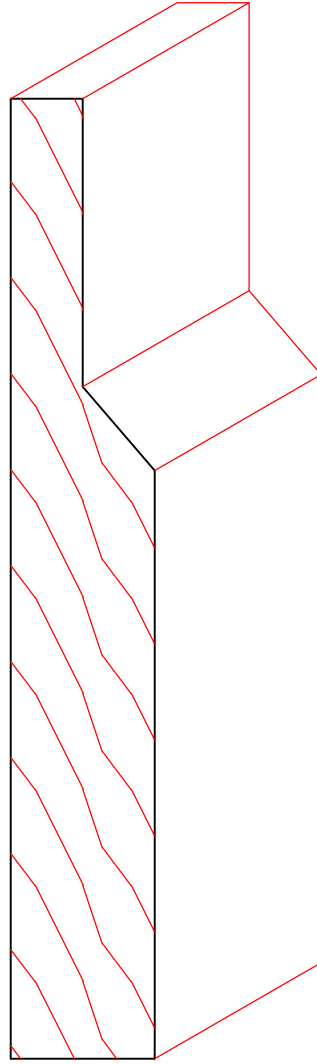

TM2147
3/4" X 5" +-

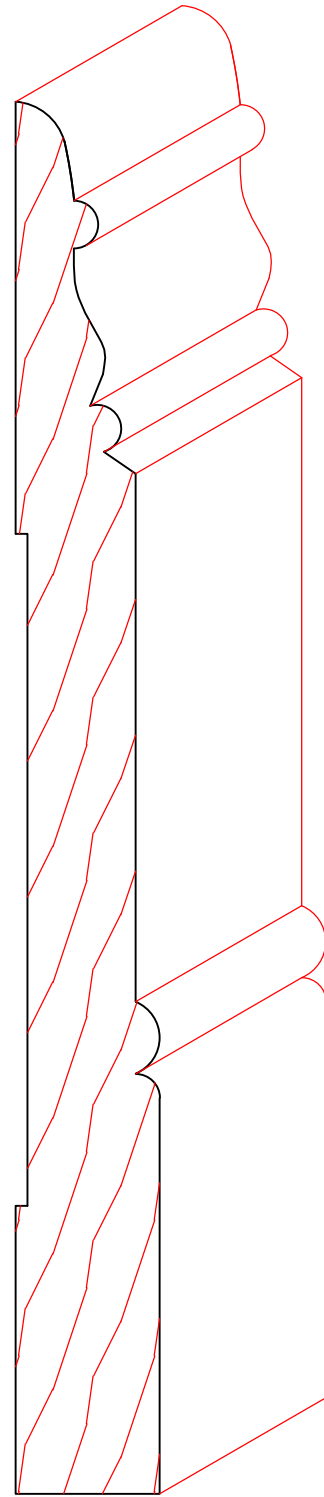

TM2148
3/4" X 7-1/4" +-

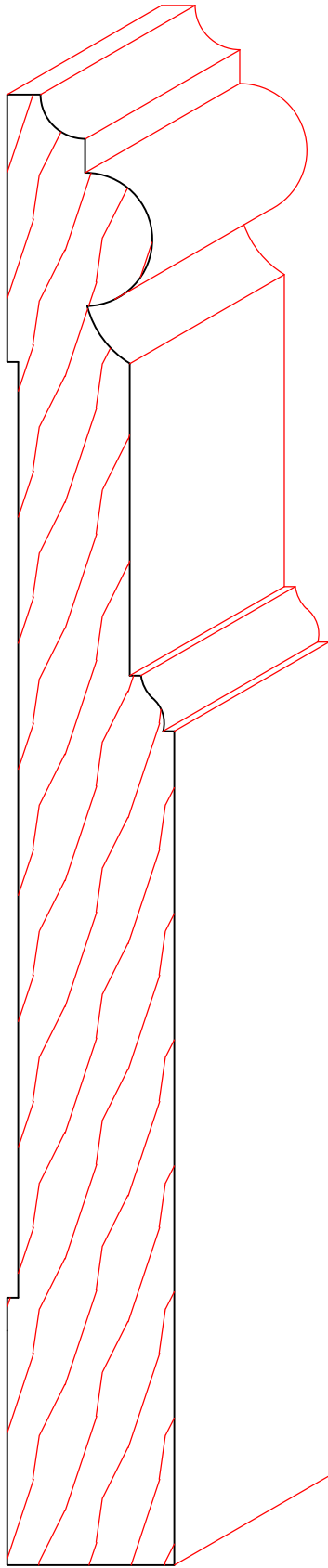

TM2149
15/16" X 8-1/4" +-

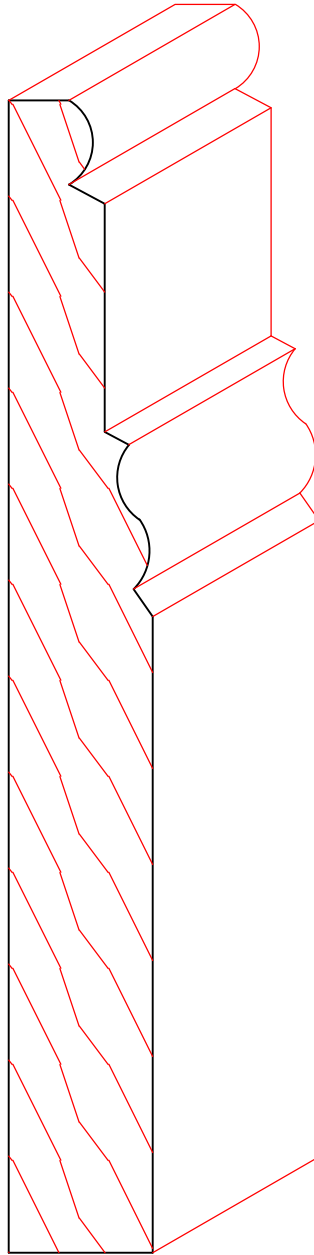

TM2150
3/4" X 6" +-

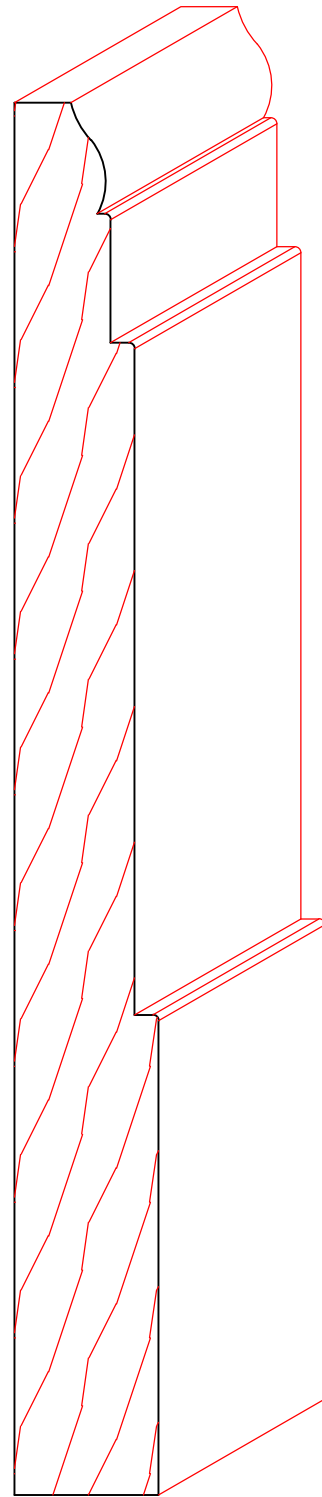

TM2151
3/4" X 7-1/4" +-

THOMAS AND MILLIKEN MILLWORK, INC.

FULL
SCALE

50

*TM2152
DOES NOT
EXIST*

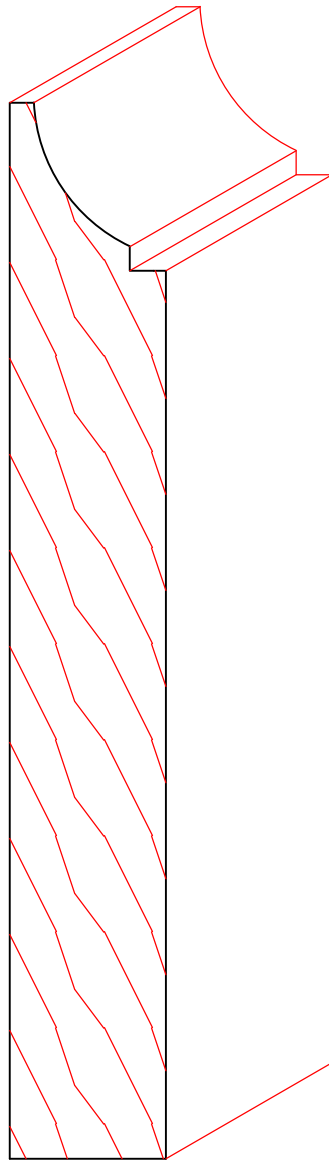

*TM2153
13/16" X 5-1/2" +-*



*TM2154
3/4" X 7-1/2" +-*

THOMAS AND MILLIKEN MILLWORK, INC.

FULL
SCALE

51

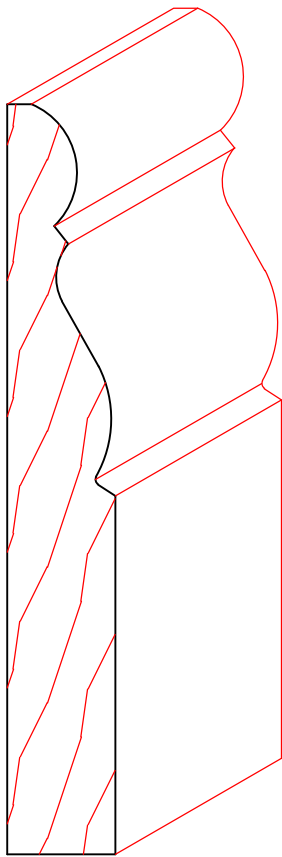

TM2155
9/16" X 3-15/16" +-

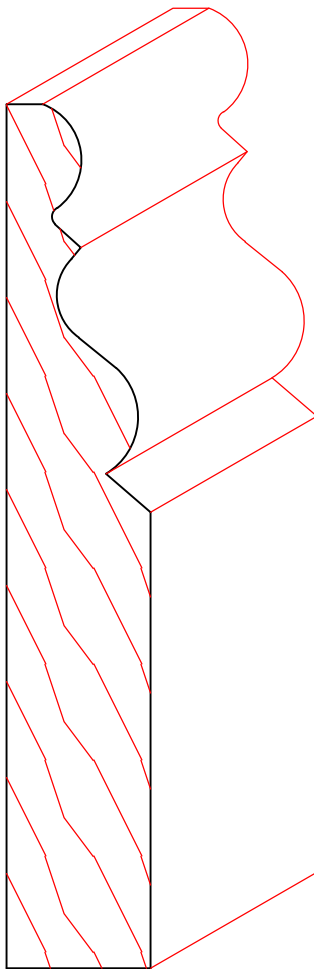

TM2156
3/4" X 4-1/2" +-

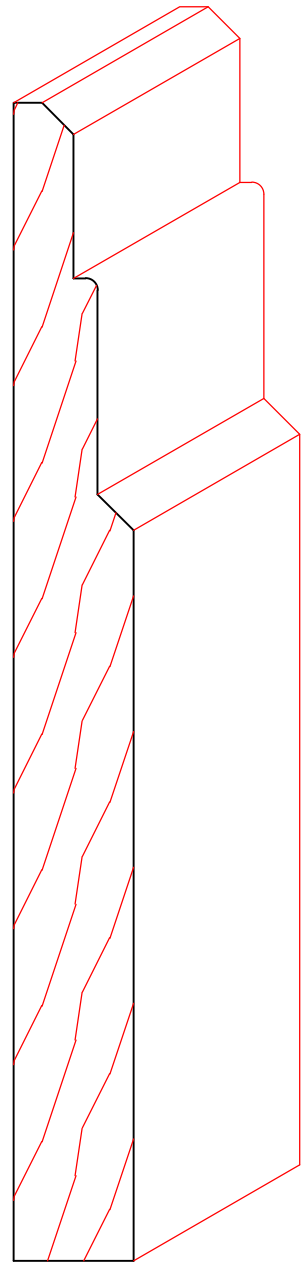

TM2157
5/8" X 6-1/16" +-

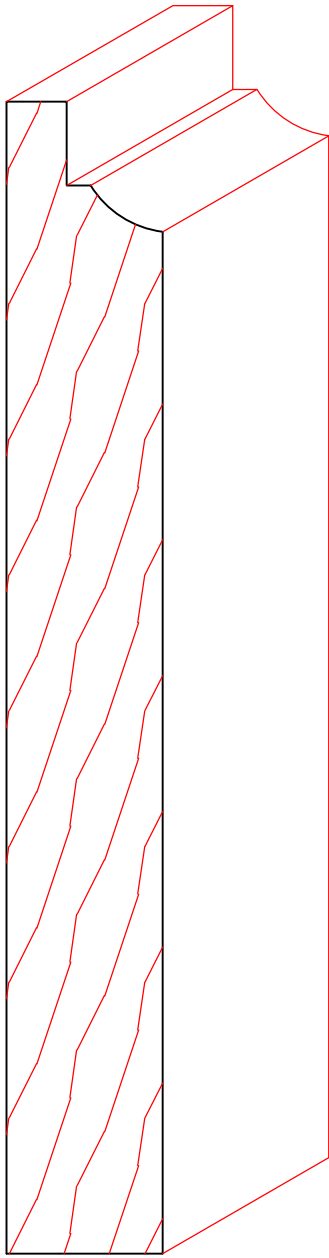

TM2158
13/16" X 6" +-

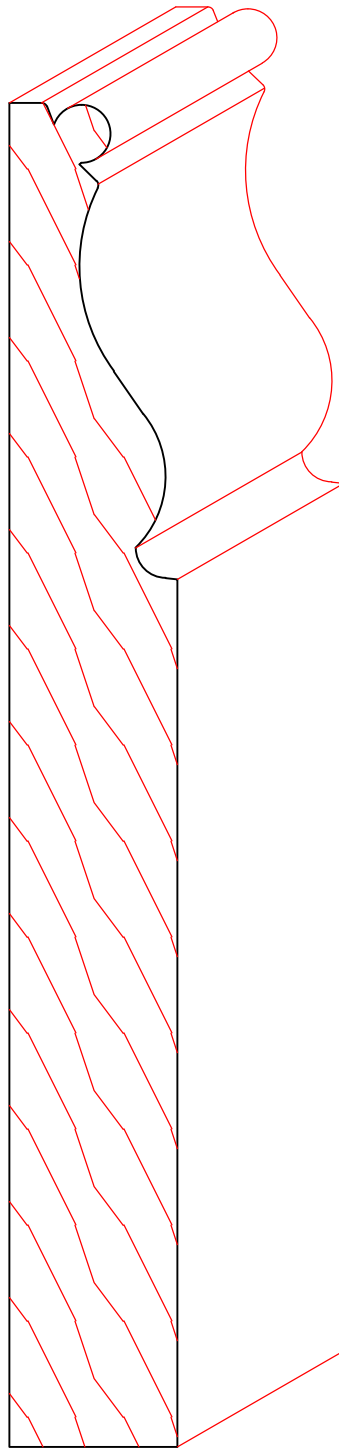

TM2159
7/8" X 7" +-

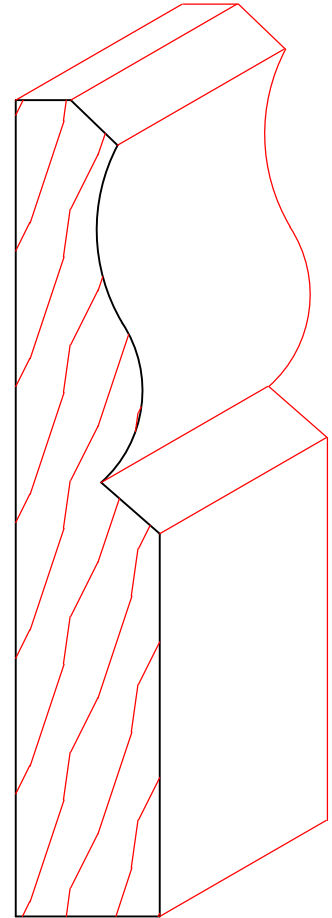

TM2160
3/4" X 4-1/4" +-

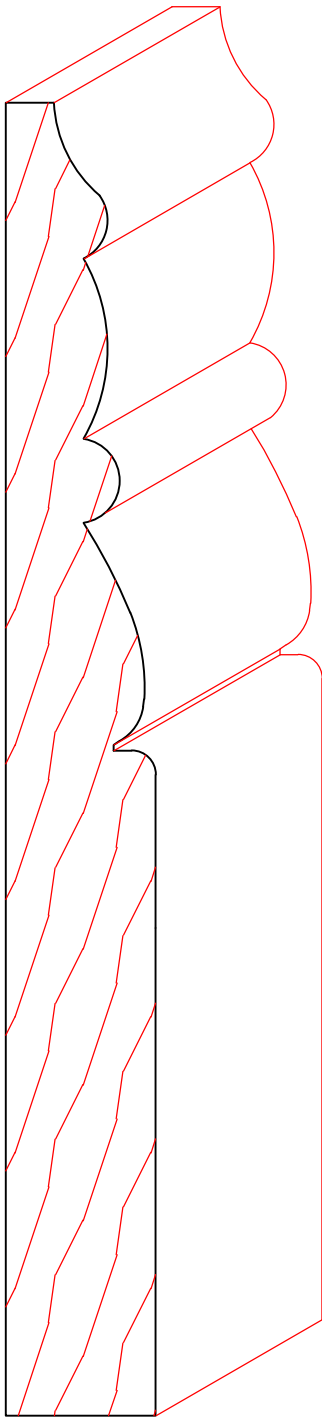

TM2161
3/4" X 6-13/16" +-

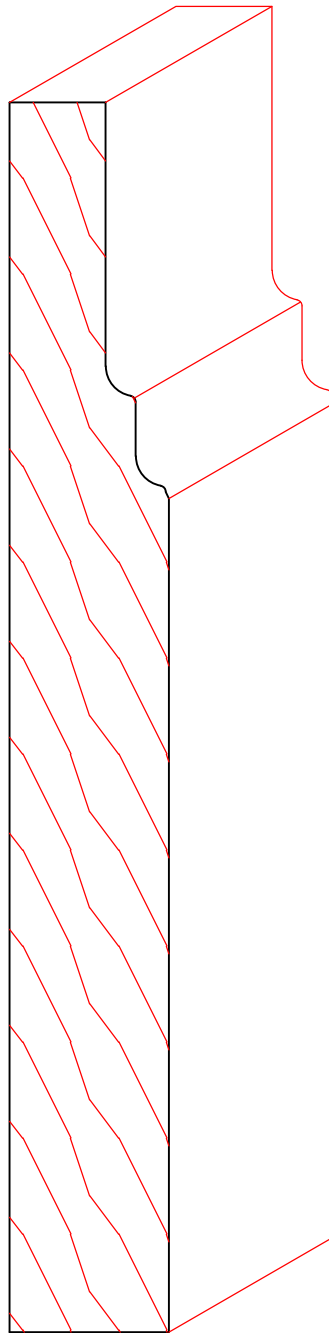

TM2162
13/16" X 6-3/8" +-

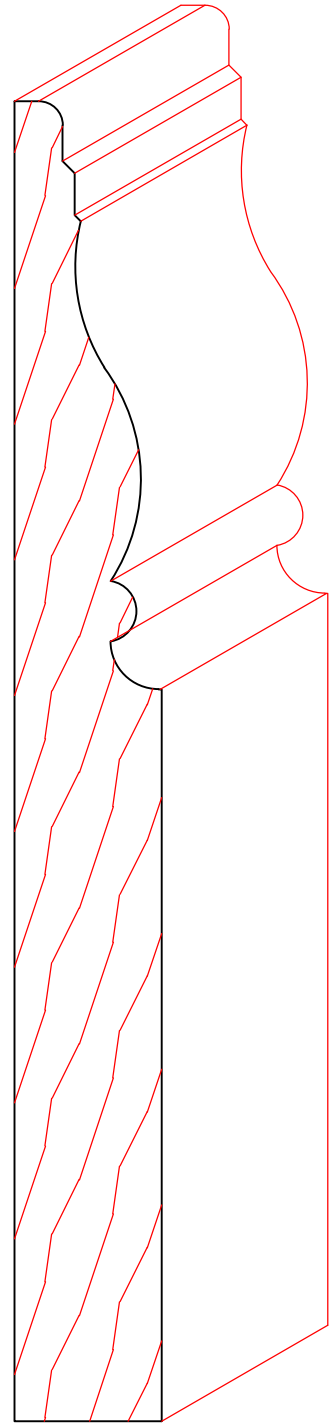

TM2163
3/4" X 6-7/8" +-

THOMAS AND MILLIKEN MILLWORK, INC.

FULL
SCALE

54

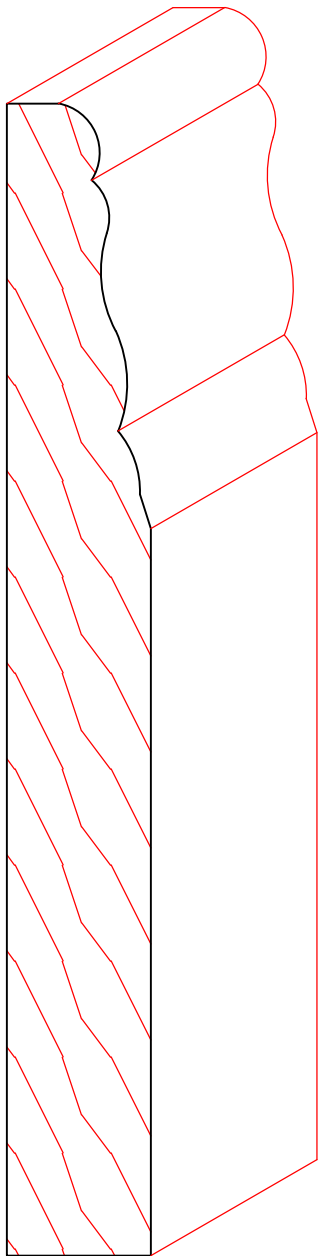

TM2164
3/4" X 6" +-

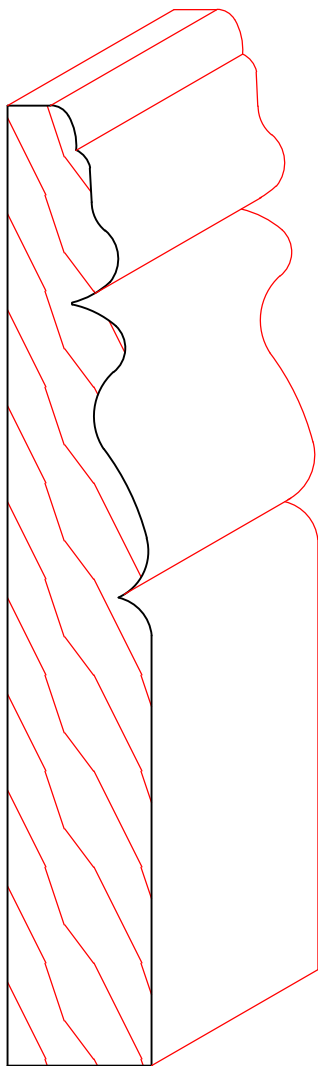

TM2165
3/4" X 5" +-

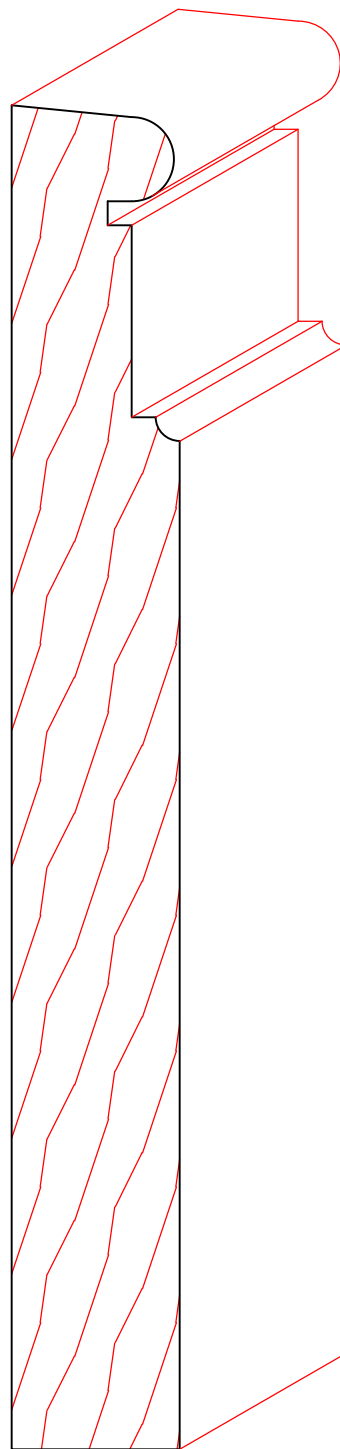

TM2166
7/8" X 7" +-

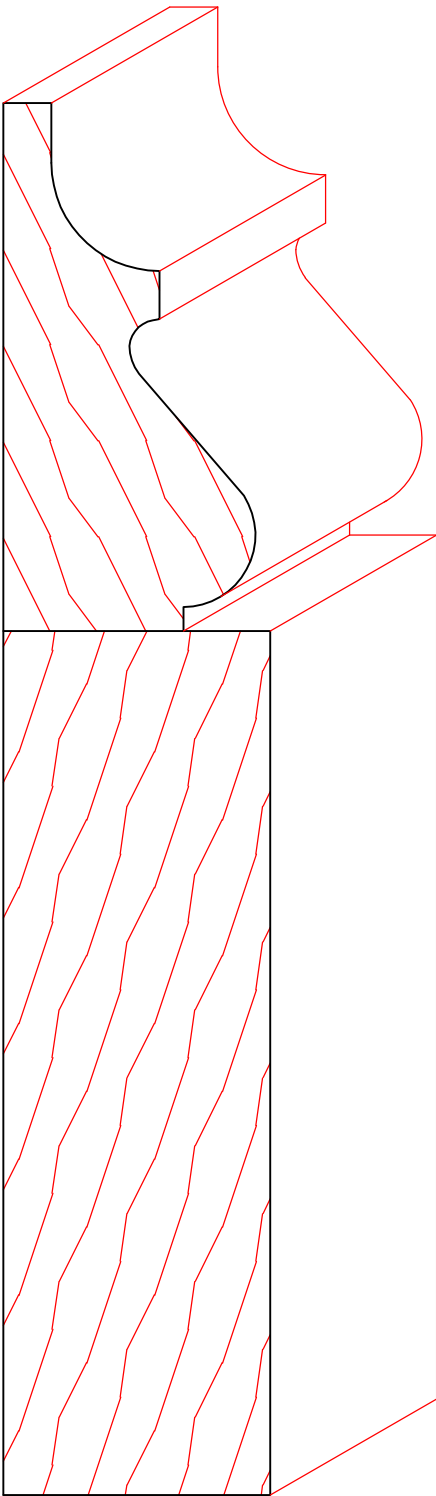

TM2167
1-3/8" X 7-1/4" +-

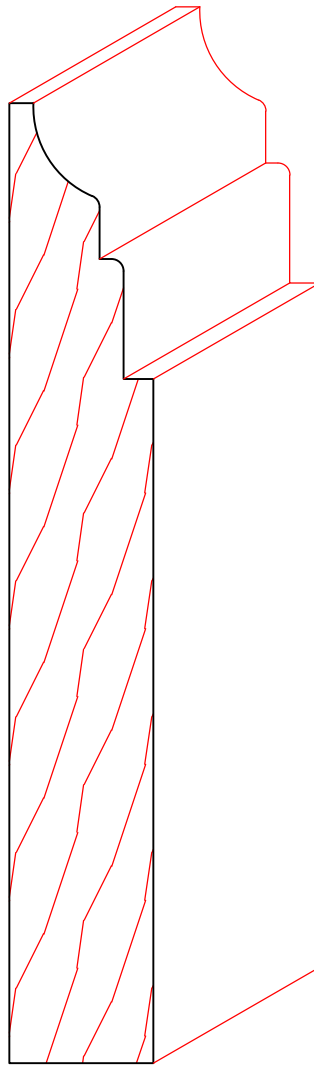

TM2168
3/4" X 5" +-

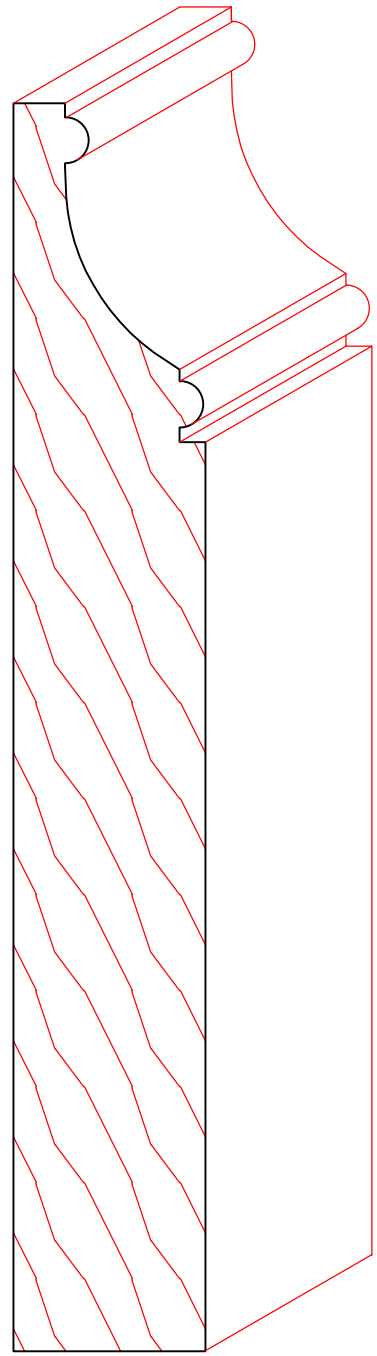

TM2169
1" X 6-1/2" +-

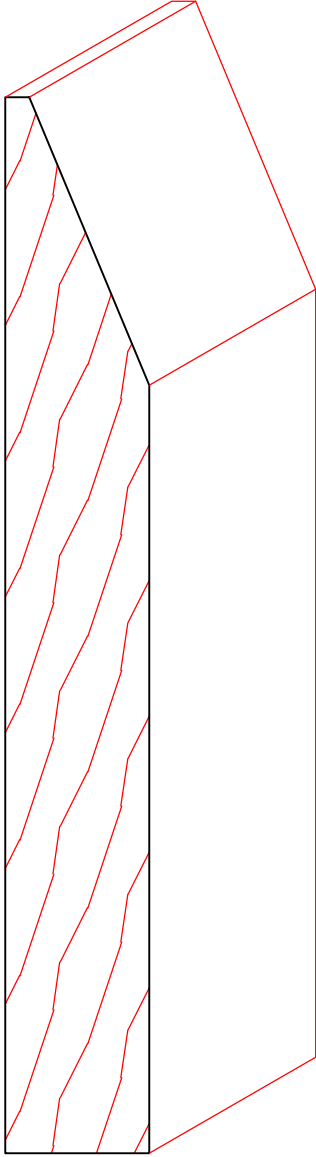

TM2170
3/4" X 5-1/2" +-